



hyperMILL[®]

AEROSPACE Solutions

Innovative Solutions
Designed to Meet
Tough Challenges

AEROSPACE

 **OPEN MIND**
THE CAM FORCE

Do you want to deliver products that exceed technical and performance requirements?

As one of the most technically challenging and safety critical industries in the world, aerospace manufacturers are continually faced with growing pressure to develop new manufacturing methods to reduce production times and increase efficiency. A core factor in the supply chain is the selection of a suitable CAM solution that can manufacture increasingly complex parts with efficiency, precision and verified confidence.

OPEN MIND offers *hyperMILL*® that is the benchmark CAM system in the aerospace industry. *hyperMILL*® incorporates intelligent solutions and aerospace-specific modules to meet the challenges of the aerospace industry. It has the capacity to reduce lead times thanks to innovative strategies and high material removal rates.

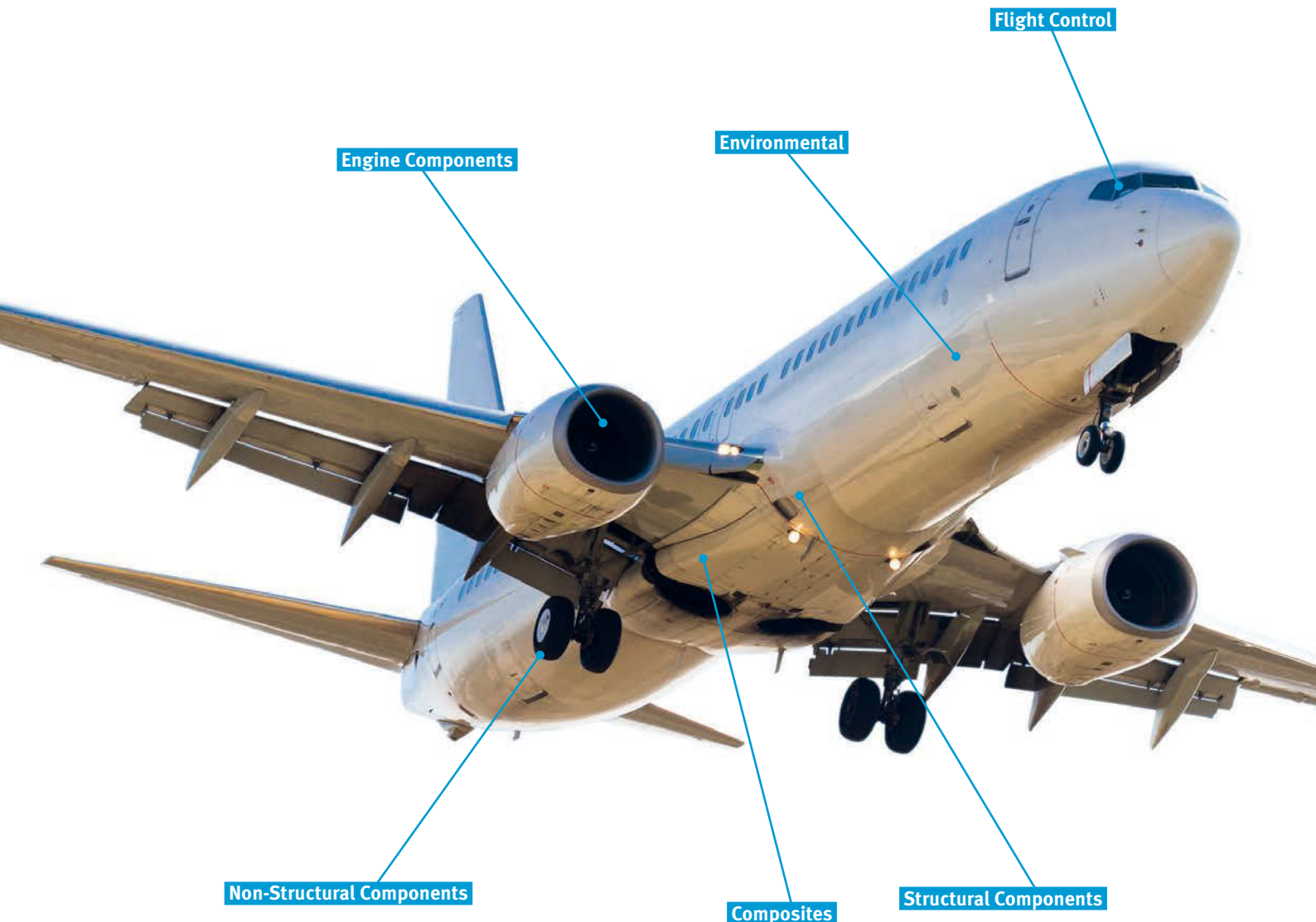

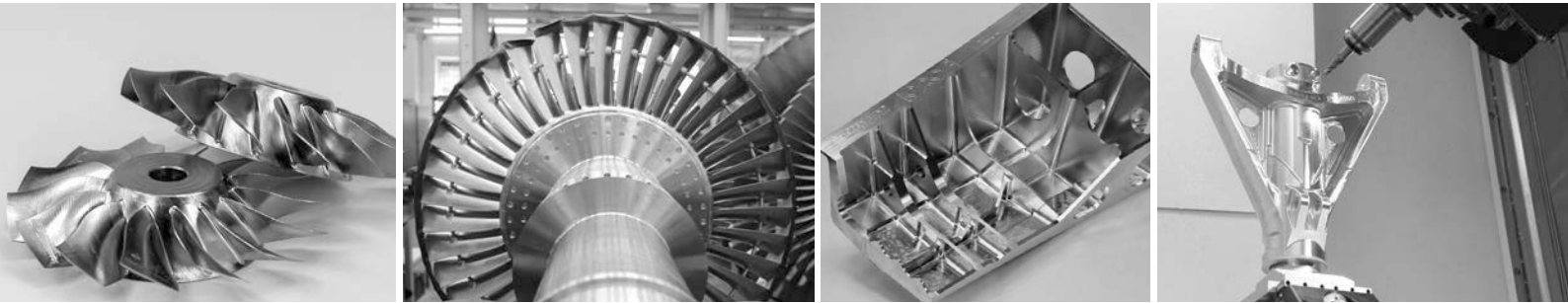

■ Industry Challenges

The aerospace industry continues to innovate and strive towards more efficient and environmentally friendly performance. Safety, comfort and efficiency continue to evolve, as does the need to travel faster and carry more passengers while also retaining profitability.

How *hyperMILL*® can help:

- Intuitive yet powerful to handle high mix, low volume production
- Supports advanced manufacturing methodologies to lower buy-to-fly ratio
- Capturing of in-house developed processes and best practices
- Enables digital thread for certification and regulatory compliance
- Lower footprint as single setup 5-axis machining eliminates secondary operations

■ The Manufacturing Challenges

Manufacturers need to have a perfect synergy between the CAM software, machine tool and the cutting tool. The solution must deliver unparalleled levels of productivity, reliability and versatility.

How *hyperMILL*® can help:

- Reduced cycle times
- Superior surface finishes
- Increased tool life
- Process repeatability
- Safety & stability

■ Business Challenges

Long-term program developments with pioneering solutions for the ‘next generation’ of aircraft challenges are a prerequisite of the industry. At OPEN MIND, we understand that the aerospace industry faces challenges that reach beyond delivery to technical and performance challenges under cost and scheduling pressures.

How *hyperMILL*® can help:

- Higher productivity & greater cost efficiencies
- Reduced lead-times and a streamlined supply chain
- Cutting-edge innovation developed in partnership with OEMs & industry visionaries
- Cost savings by doing it right first time (eliminates scrap & machine damage)
- Digitization and automation for lights-out production

■ The Design/Technical Challenges

Industry requires technologies that will enhance productivity and efficiency with features that can rapidly expedite parts from programming through production with consideration for aerospace specific factors such as materials, applications and strategies for the machine tool.

How *hyperMILL*® can help:

- Machining of complex shapes
- Machining of large size components due to parts consolidation
- Handle exotic materials
- Reduced programming times
- Import various CAD formats for CAM

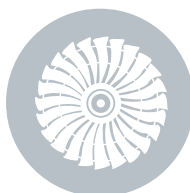

Beating the Competition

Complex workpieces, difficult-to-machine materials and short lead-times are increasingly a pre-requisite of the aerospace sector. *hyperMILL*[®] is the benchmark CAM solution in meeting and exceeding expectations with all these business pressures. OPEN MIND provides the perfect NC programming platform for all machining processes, whether it is the complex environment of structural or non-structural assemblies or safety and performance critical components such as engine and fuselage parts.

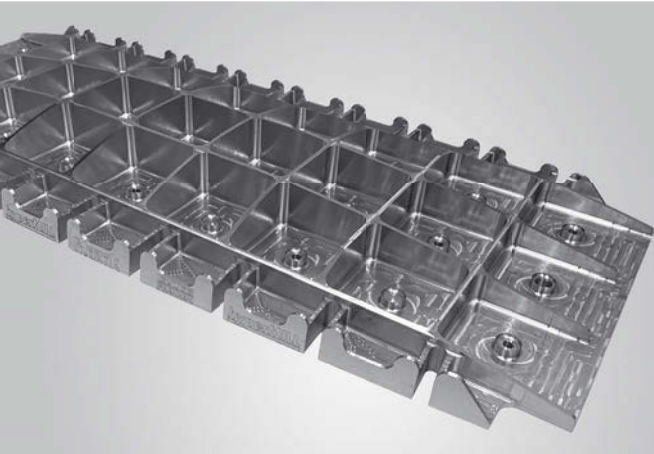

Structural Parts

Challenges

- Conducting extensive pocket and profile milling through ingenious strategies
- Achieving high-quality surface finishes while maximizing productivity
- Successful elimination of chatter and vibration during machining and finishing of thin walls
- Increased process security and reliability even when massively boosting productivity

Materials

- Aluminum
- Titanium
- Composites
- Inconel
- CFRP

Wings | Pylons | Fuselage | Couplings | Flap Tracks |
Tail | Assembly | Links | Brackets | Frames | Ribs | Skins

Engine Components

Challenges

- High material removal rates on airfoils, edges, hubs & fillet, thin wall parts and complex parts.
- Maintaining tight geometric tolerances and quality on critical components
- Maximizing productivity and optimizing surface finishes on parts

Materials

- Titanium
- HRSA
- Inconel
- Stainless Steels



Rings | Discs | Blisks | Blades |
Casings | Impellers | Housings |
Guide Vanes

Non-Structural Parts

Challenges

- Boring high precision holes with absolute repeatability
- Maximum metal removal when slotting and profiling
- Choosing cutting tools and techniques suitable for deep pocketing combined with short cycle times and high metal removal rates

Materials

- Aluminum
- Titanium
- Steel
- Composites

Links | Shafts | Beams | Brakes | Sliders |
Brackets | Axial Beams | Main Cylinders

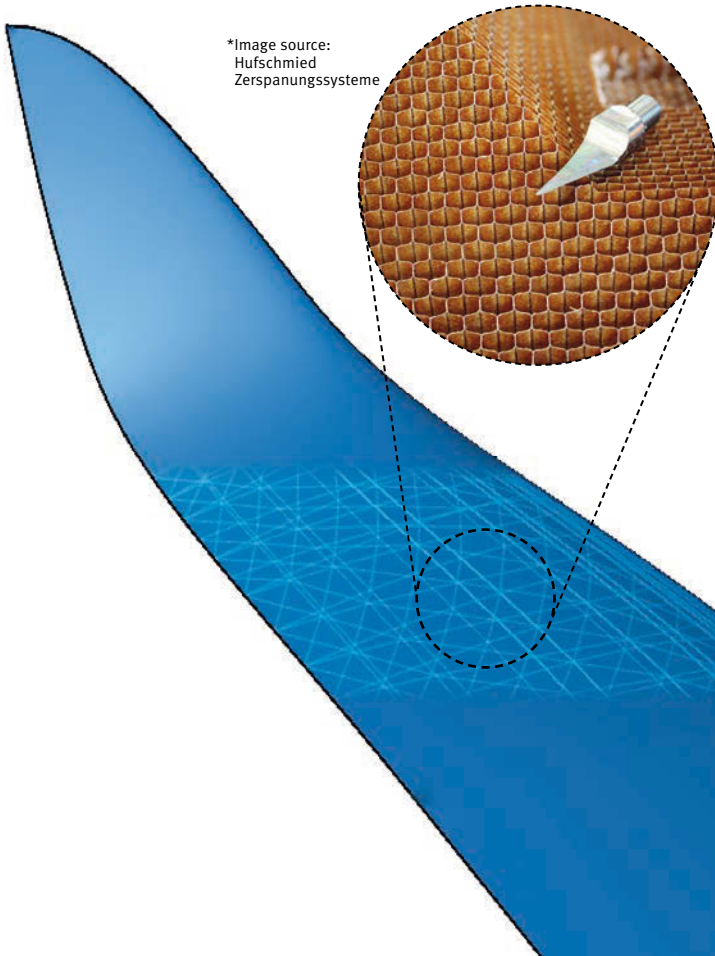

*Image source:
Hufschmied
Zerspanungssysteme

CAM Solutions for Aerospace Applications

2.5D machining

hyperMILL® 2.5D machining is typically used for structural parts where there are numerous pockets, plane levels, contours and holes. Intelligent mechanisms detect pocket and drilling features and speed up programming even further.

3D machining

hyperMILL® offers powerful and precise functions for 3D milling. It allows users to manufacture high-quality surfaces quickly and reliably, even with complex workpieces. Numerous strategies for roughing and finishing ensure efficient 3D machining.

Leading 5-axis

hyperMILL® 5-axis technology is ideal for working with challenging geometries. *hyperMILL*® offers a wide range of powerful strategies for simultaneous and indexed roughing and finishing. This allows users to enhance the production of high-quality surfaces.

hyperMILL® MILL-TURN Machining

Powerful mill-turn strategies are completely integrated into *hyperMILL*®. This allows the tool database, stock tracking, collision checking and postprocessors to be used jointly for all milling and turning operations.

CAD for CAM

With *hyperCAD*®-S, OPEN MIND has developed its own CAD system that is ideally tailored to the needs of CAM programming. The advanced and extremely powerful system is the perfect solution for mastering all kinds of daily challenges that arise when working with meshes, faces and solids.

Compatibility

hyperMILL® offers all prerequisites for successful integration with existing system landscapes such as PDM, PLM, MES and TMS.

Postprocessor

High-end postprocessors are optimally tailored to the requirements of customers. These postprocessors ensure error-free transfer from CAM to the actual NC Program.

hyperMILL® MAXX Machining

Reducing machining times and delivering on schedule is essential. *hyperMILL*® MAXX Machining offers innovative drilling, roughing and finishing strategies that can deliver time savings up to 90 percent.

Turbomachinery

With packages for the machining of impellers, blisks and turbine blades, *hyperMILL*® offers solutions for the complete machining of complex part geometries for the aerospace industry. Intelligent automated functions, optimized milling strategies and a simple workflow allows users without special expertise to effectively program challenging parts.

Adaptive Machining

hyperMILL® is ready to be used for Adaptive Machining. A team of experts are on-hand to support you on-site to help you take advantage of improved quality and reduced cycle times when machining aerospace components.

Automation

Users can automatically program drill holes, pockets, part variations and part families using the feature and macro technology. The automation technology from OPEN MIND is one of the most advanced tools available to fulfil the needs of aerospace manufacturers. Our experts can create tailored solutions to fully automate CAM processes.

Additive Manufacturing

hyperMILL® ADDITIVE Manufacturing is a powerful solution that allows you to perfectly and flexibly control and integrate both additive and subtractive machining processes.

Simulation and Verification

Realistic simulations and safety mechanisms are increasingly important to ensure efficient and safe set-up processes. *hyperMILL*® VIRTUAL Machining offers a real NC code simulation as well as numerous optimizing and analyzing tools.

6-axis simultaneous Knife cutting

Honeycomb materials are used as strong and light weight alternatives that need special technologies like ultrasonic knife cutting. *hyperMILL*® offers innovative CAM solutions for easy and safe programming of 6-axis simultaneous knife cutting of such materials.

Why is *hyperMILL*[®] the first choice CAM solution for the aerospace industry?

- Industry leading innovative technologies
 - Intuitive, user friendly and easy to program
 - All technologies delivered in a single user interface
 - Dedicated turbomachinery package
 - CAD independent system that works with all popular PLM systems
 - Global network that is fully supported by OPEN MIND experts
 - In-house developers that instantly and flexibly react to industry trends and innovations
 - Best in class 5-axis technology
 - Cutting edge technology that incorporates Digitization and Industry 4.0 interfaces
 - Customized solutions
- 

A Trusted Name in the Aerospace Industry

Efficient and reliable machining

hyperMILL® is one of the world's most powerful CAM solutions for machine and controller independent programming. The system provides highly innovative, flexible and powerful CAM strategies that allow manufacturers to achieve quality, time and cost targets quicker than ever before, especially on complex challenging parts.

Leading 5-axis Technology

OPEN MIND was one of the first CAM manufacturers to tackle 5-axis machining technology and it remains one of the world's leading developers of unique innovative 5-axis CAM strategies. This expertise and close partnerships with well-known machine tool, cutting tool and industrial manufacturers contribute to the continuous development of the *hyperMILL*® CAM solution. *hyperMILL*® features a broad range of powerful 5-axis strategies for rough and finish machining of the most challenging geometries, free-form surfaces and deep cavities.

Advantages

- Process reliability through fully automated collision checking and avoidance
- User friendly simple programming structures that require little expertise
- Ability to apply shorter, more stable cutting tools to enhance performance
- Ease of programming and set-up for the machining of complex parts
- Reduced machining times
- Improved surface quality
- Unparalleled flexibility

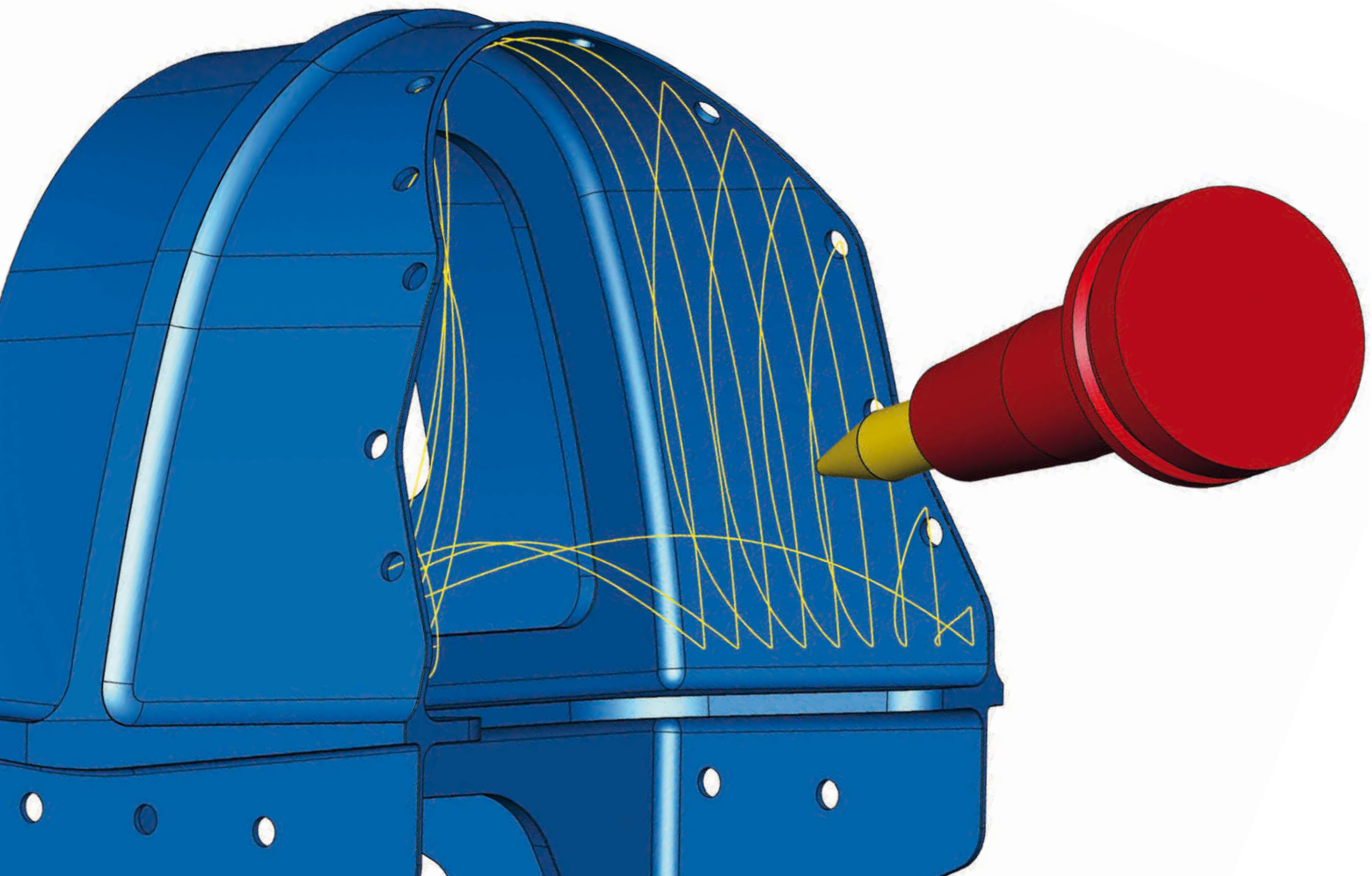

hyperMILL® MAXX Machining

Machining at speed with process reliability is more crucial than ever. *hyperMILL®* MAXX Machining allows you to significantly reduce machining times with three innovative modules.

Drilling

5-axis helical drilling allows you to create cavities with very high material removal rates. This method is perfect for difficult to machine materials.

Advantages

- Fast and efficient plunging with strategies dedicated to cutting hard materials
- Excellent for opening deep cavities using large milling heads
- Reduces stress and forces on cutting tools to extend tool life and process stability

HPC Roughing

High-Performance Cutting (HPC) is perfect for machining aerospace components such as turbine rings, casings and structural parts. *hyperMILL®* offers strategies for 2.5D, 3D and 5-axis HPC roughing as well as High-Performance Turning.

Advantages

- Increased process reliability
- Improved productivity and machining efficiency
- High material removal rates
- Uses proven HPC technology from Celeritive™

Finishing

Cycle time savings of up to 90 percent can be achieved through the innovative finishing strategies that use conical barrel cutters and OPEN MINDs innovative CAM strategies. Housings, structural parts and any other aerospace component with steep or flat planes can be machined extremely fast.

Advantages

- Up to 90% time savings
- Fully automatic machining of surfaces with a continuous curvature
- Hard-to-reach areas can be optimally machined
- Significantly larger line increment with the same theoretical scallop height

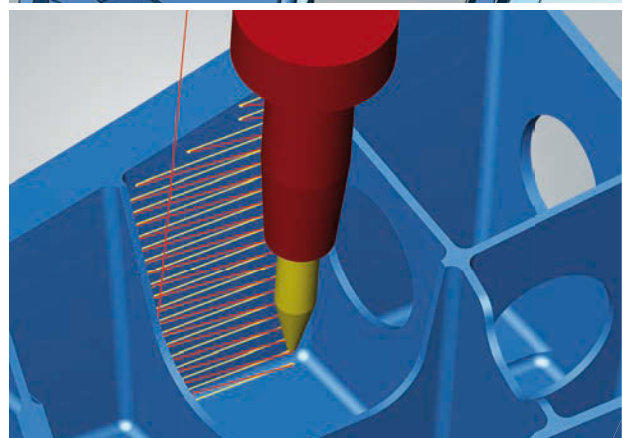
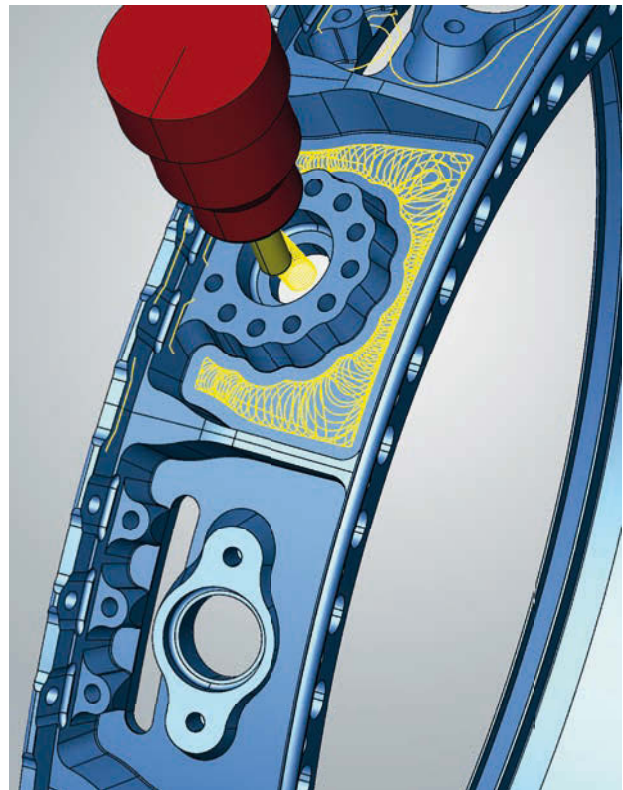
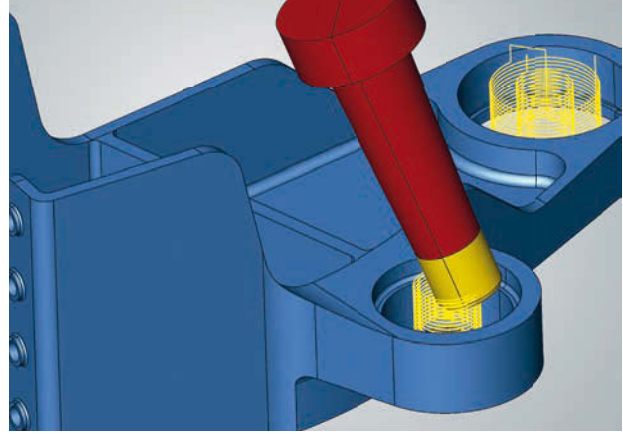

“We look for and find unique strategies for efficient machining.”

Dr. Josef Koch, CTO of OPEN MIND Technologies AG

Turbomachinery and Engine Components

Impellers, blisks and blades can be programmed with ease using the 5-axis special applications. Integrated automated functions in these packages reduce the number of entered parameters to a minimum to simplify programming. With proven collision checking, they ensure a very high level of process reliability and give complete customer confidence. The use of stable tools allows machining with high feed rate parameters that achieve superior finishes.

Advantages

- Offers the potential to apply special barrel cutters for extremely efficient machining
- Simple and intuitive programming
- Process reliability thanks to completely automated collision control and avoidance
- Tip or side entry machining possible

Highlight: *hyperMILL*® provides sophisticated finishing strategies using conical barrel cutters for finishing single or multi-blades. This method ensures significant time savings due to the larger tool path step-downs that can be achieved.

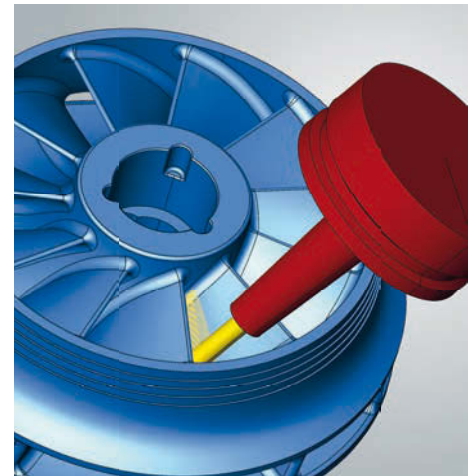
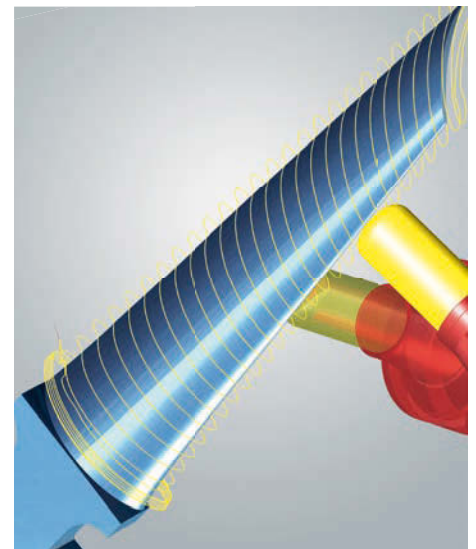
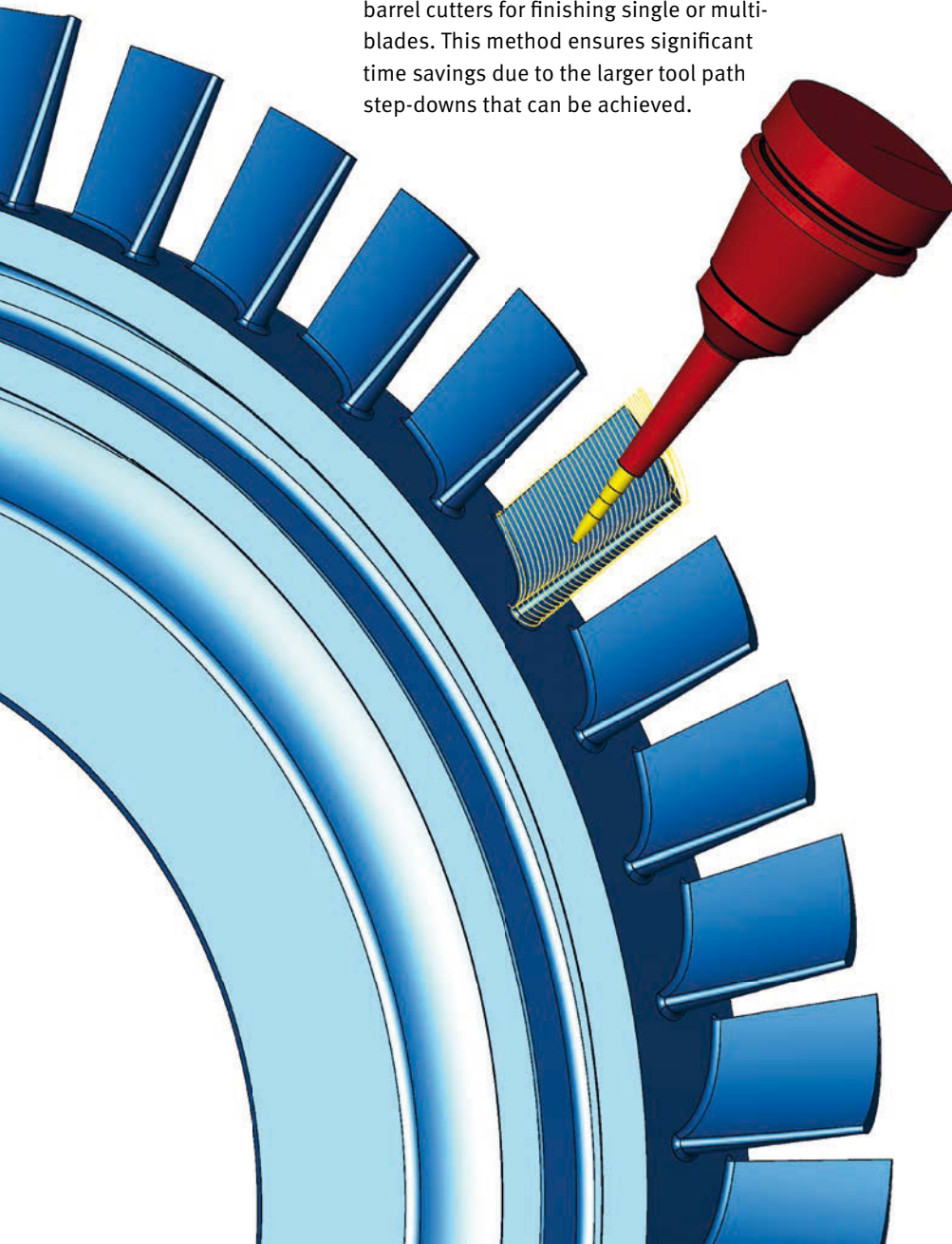

hyperMILL® offers safe and reliable 5-axis strategies with automatic collision avoidance when machining undercuts

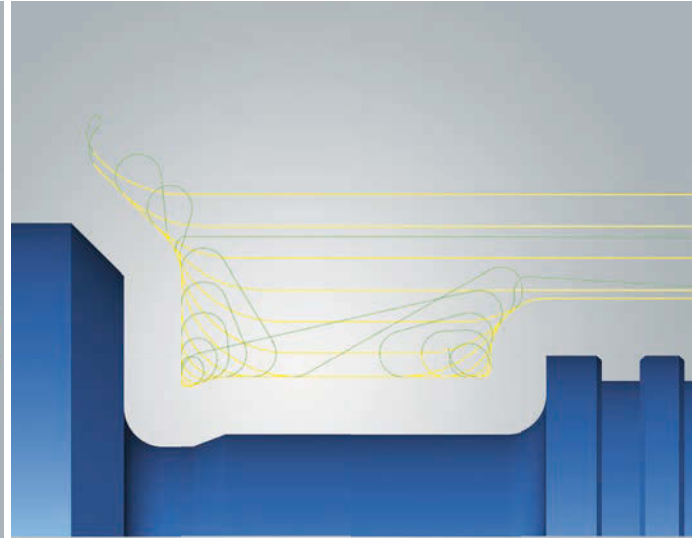
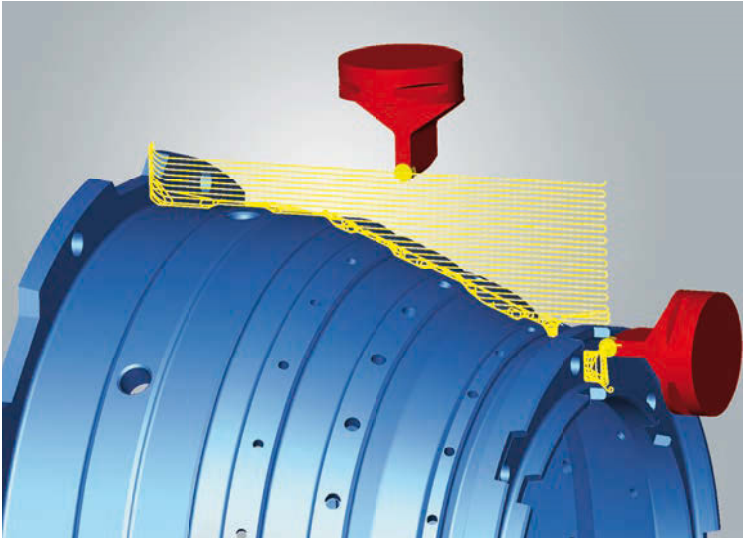

Millturn Technology

Millturning has enormous potential when it comes to manufacturing engine cases and other parts. The *hyperMILL*® MILL-TURN Machining module is fully integrated in the CAM software. The user can equally use mill/turn strategies as well as all 2.5D, 3D and 5-axis milling strategies in a single user interface.

Simultaneous turning programmed with ease

Two special strategies for simultaneous roughing and finishing make programming both simple and reliable. Simultaneous machining further boosts the mill-turning efficiency of machines with a swivel head on the third axis. Complex workpiece geometries can be machined in a single operation by simultaneously adapting the approach angle during turning.

Advantages

- Process complex contours in a single operation
- Optimal tool utilization
- High flexibility
- Easy to program

HPC Turning with *hyperMILL*® MAXX Machining

HPC turning can be quickly and easily applied to all turning operations. The connection between the individual toolpaths and their approach and retraction movements are perfectly aligned with the respective machining application. This not only significantly reduces the machining time, but also increases tool life substantially. This strategy is perfect for machining the hardest materials like inconel or titanium.

Advantages

- Increased process reliability especially with difficult to machine materials
- Improved productivity
- Simple programming
- Uses proven HPC technology from Celeritive™

Simulation and Verification

Components are becoming ever more complex, yet turn-around times keep getting consistently shorter. As a result, manufacturers must make optimum use of their machine tools. *hyperMILL*® VIRTUAL Machining offers three groundbreaking modules: Center, Optimizer and CONNECTED Machining. These modules help to significantly strengthen the interaction between *hyperMILL*® CAM software and the machine tool. Networking and virtually mapped processes make it possible to evaluate, control and optimize machining operations more reliably - before the machine ever runs.

Advantages

- Simulation based on NC code
- Full simulation of all movements, including transition movements
- 'Best Fit' function for optimal placement of the component in the workspace
- Safe workspace monitoring
- Automatic solution selection for multi-axis positions
- Optimized movements
- Bi-directional linking of NC block and *hyperMILL*® job enables quick comparison of the respective machining job

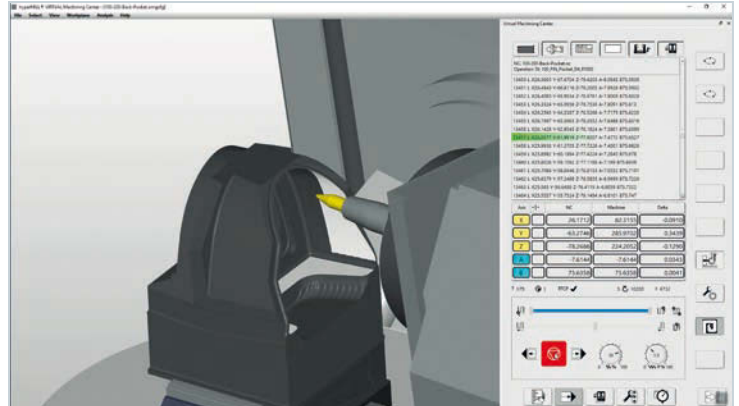

hyperMILL® VIRTUAL Machining simulates the NC code line for line, including all transition movements

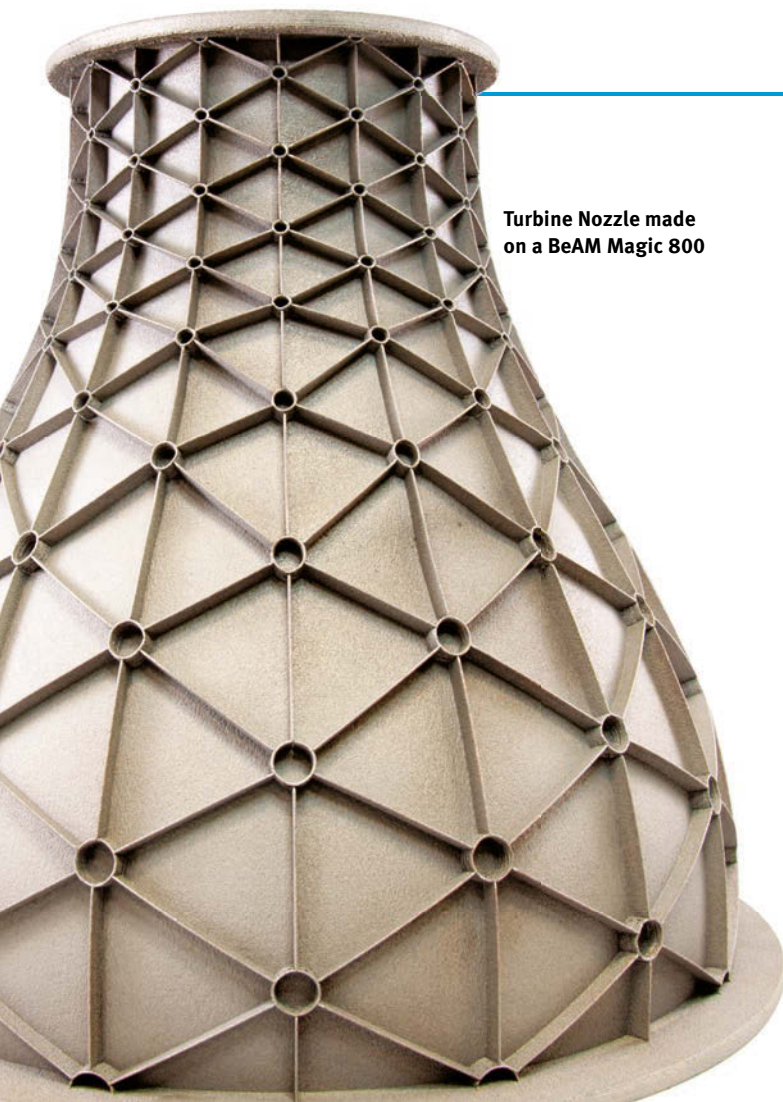

Turbine Nozzle made on a BeAM Magic 800

Additive & Hybrid Machining

Additive manufacturing and 3D printing are now opening up new opportunities for the aerospace industry. Using an innovative CAD/CAM solution is essential in order to take full advantage of this potential – and that's where *hyperMILL*® comes in. *hyperMILL*® ADDITIVE Manufacturing is an extremely powerful solution. It allows you to perfectly, flexibly control both additive and subtractive processes.

Advantages

- Produce parts with hybrid material properties
- Opportunity to produce hollow shapes
- Tooling repair
- Potential to repair, refurbish and upgrade aerospace component
- A CAM system for all additive and subtractive machining tasks

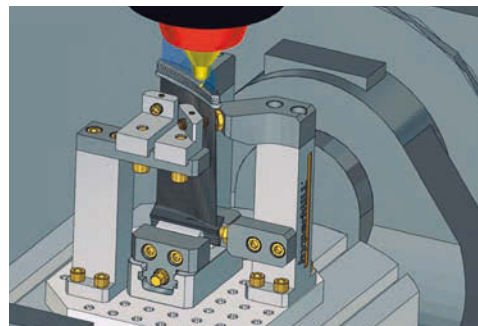

Adaptive Machining of High Precision Forged Single Blades

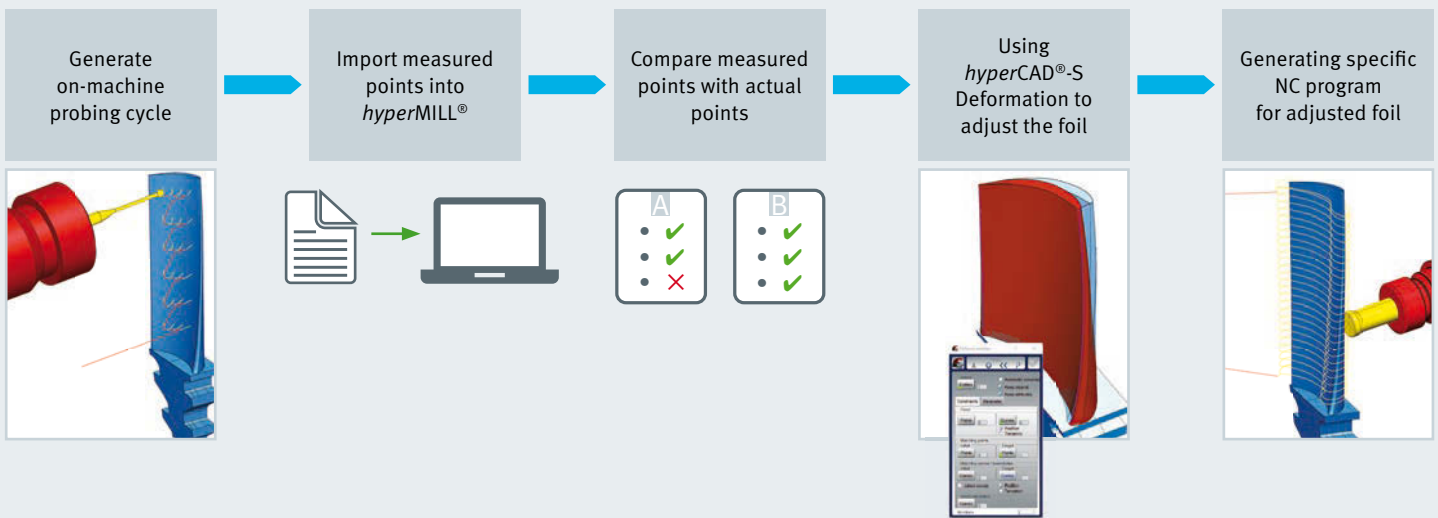

Adaptive Manufacturing and Automation

Adaptive manufacturing allows the machining of parts that have geometric differences between one component and the next when undertaking batch or series production. This is particularly evident in castings and forgings that have inherent differences due to shrinkage, such as turbine blades. In such cases the blade geometry is digitally captured, and a unique toolpath is generated that machines the blade to the required shape, regardless of the surface variations.

NC Programming With Features and Macros

Standardization and automation are two examples of how feature technology is used. Geometry information from the CAD model is used automatically for CAM programming and can be accessed at any time. For a CAM programmer, a macro is a defined sequence of machining steps that

contains all of the tool and technology data for a feature. In practice, macros enable NC programming with a click of the mouse and make it possible to greatly reduce the amount of programming required.

Advantages

- Increased efficiency thanks to reduced machining and programming times
- Improved process reliability and quality
- Possibility to customize approaches and workflows
- Capturing of company expertise
- Enhanced individual and business-related scope for action thanks to simplified programming

Adaptive Machining: LFW Blisk

Challenges:

- › Every blade after welding is different
- › Measuring the blade's shape & position
- › Achieve smooth blending between blade and hub

Automated Solution

- › On machine tool probing
- › Auto designing & blending of surface (CAD) on real position
- › Auto recalculate & generate unique NC code for each blade
- ➔ 100% automated – no human interaction

Adaptive Machining: Wing structure

Challenges:

- › 100 % Automation to eliminate risk of human error
- › Wing connections = Bottleneck in production
- › Manually takes 3 days for CAD engineer

Automated Solution

- › Input and scan STL file
- › STL position aligned with original CAD model
- › Each single step is checked for quality
- › NC file generated automatically
- ➔ Takes only one hour with *hyperMILL*®

OPEN MIND – A long-standing worldwide Aerospace Industry CAM Partner

Exceptional Aerospace Expertise

OPEN MIND is present in all the major aerospace markets in Asia, Europe, North and South America. OPEN MIND subsidiaries and qualified partners are heavily involved in numerous OEM and supply chain projects. OPEN MIND has proven time and again how its extensive know-how and the features within the innovative CAM software have delivered astounding programming and production benefits for the aerospace industry on every continent.

hyperMILL® has also established itself as a CAM system that enables user friendly and easy programming of the most complex parts, such as impellers and blisks, turbine blades, engine housings and structural parts. Whatever the challenge, OPEN MIND can deliver a solution.



Customer-Specific Solutions

OPEN MIND offers comprehensive consulting services with unsurpassed expertise in aerospace machining. You can find the right solution for your aerospace project with the OPEN MIND consulting team. Customized OPEN MIND service concepts allow companies to significantly increase productivity and further boost competitiveness.

Consulting projects:

- Automation
- Adaptive machining
- Technology adoption
- Cycle time optimization
- Audit of manufacturing process
- Upgrade from 3-axis to 5-axis

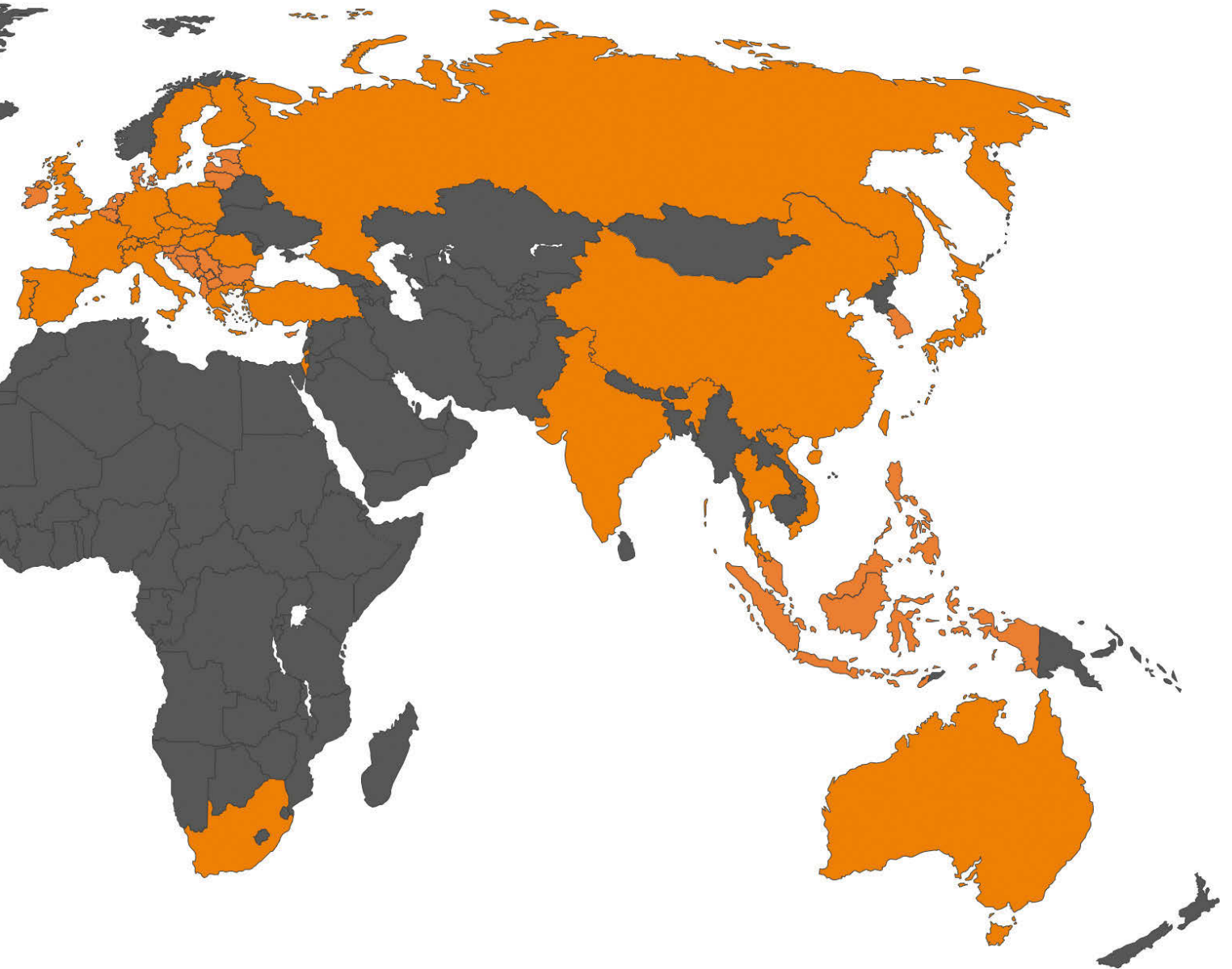

Headquarters OPEN MIND Technologies AG
Phone: +49 8153 933-500
E-mail: Info.Europe@openmind-tech.com
Support.Europe@openmind-tech.com

UK OPEN MIND Technologies UK Ltd.
Phone: +44 1869 290003
E-mail: Info.UK@openmind-tech.com

France OPEN MIND Technologies France SARL
Phone: +33 3 88 031795
E-mail: Info.France@openmind-tech.com

Italy OPEN MIND Technologies Italia Srl
Phone: +39 02 93162503
E-mail: Info.Italy@openmind-tech.com

Spain OPEN MIND Technologies Spain S.L.
Phone: +34 960 04 55 02
E-mail: Info.Spain@openmind-tech.com

USA OPEN MIND Technologies USA, Inc.
Phone: +1 888 516-1232
E-mail: Info.Americas@openmind-tech.com

Brazil OPEN MIND Tecnologia Brasil LTDA
Phone: +55 11 2424 8580
E-mail: Info.Brazil@openmind-tech.com

Asia Pacific OPEN MIND Technologies Asia Pacific Pte. Ltd.
Phone: +65 6742 95-56
E-mail: Info.Asia@openmind-tech.com

China OPEN MIND Technologies China Co. Ltd.
Phone: +86 21 588765-72
E-mail: Info.China@openmind-tech.com

India OPEN MIND CADCAM Technologies India Pvt. Ltd.
Phone: +91 80 2676 6999
E-mail: Info.India@openmind-tech.com

Japan OPEN MIND Technologies Japan K.K.
Phone: +81 422 23-5305
E-mail: info.jp@openmind-tech.co.jp

Taiwan OPEN MIND Technologies Taiwan Inc.
Phone: +886 2 2957-6898
E-mail: Info.Taiwan@openmind-tech.com

OPEN MIND Technologies AG is represented worldwide with own subsidiaries and through competent partners and is a member of the Mensch und Maschine technology group, www.mum.de



We push machining to the limit

www.openmind-tech.com