

# hyperMILL®

Perfect. Precise. Programming.



## **CAM strategies** and functions for efficient manufacturing

CAM STRATEGIES



# Table of contents

Page



**User interface**

3



**2D strategies**

9



**3D strategies**

17



**HSC functions**

25



**5axis machining**

29



**Specialised applications**

37



**Mill/turn strategies**

47



**General functions**

53



**Feature and macro technologies**

63



**Post-processors and simulation**

71

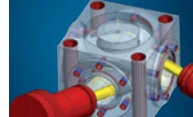

**Strategy overview**

75

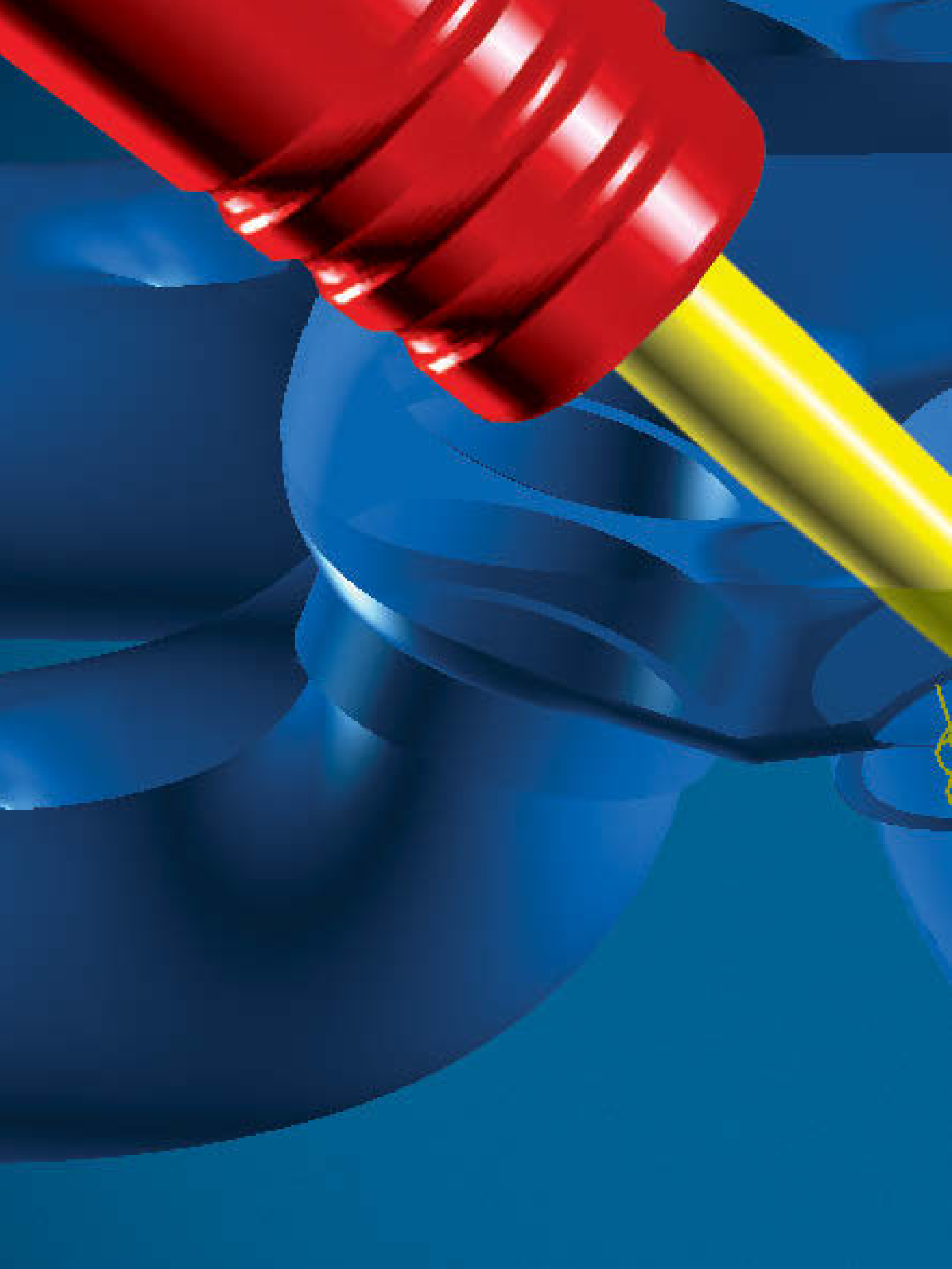



## User interface

*hyperMILL*® covers a very wide variety of machining strategies, ranging from Turning and Milling with 2D, 3D and HSC applications, all the way through to 5axis simultaneous and dedicated special applications. All these strategies are accessible from a single, coherent user interface. Administrative tools, such as job lists or component jobs, enable a highly transparent and reliable workflow. Functions such as associative programming or parameter programming reduce programming times. This programming philosophy simplifies training and daily usage.

## Windows-oriented user interface

→ Easy handling, single interface for all strategies, swift and secure programming

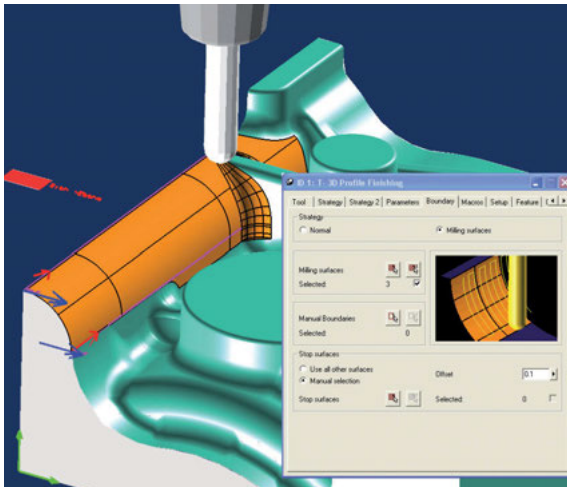

Graphical user interface

Working with *hyperMILL*® is easy, as users are already familiar with the operating principle. The Windows look and feel facilitates user input. Clearly structured dialog boxes with a graphical and menu-guided user interface help users in their programming tasks.

Individual jobs as well as complete job lists can be copied within and between projects using a drag-and-drop procedure. Tried and proven technology sequences can be transferred between similar projects at the click of a mouse.

## Rapid result technology

→ Fast programming and modification with minimal errors

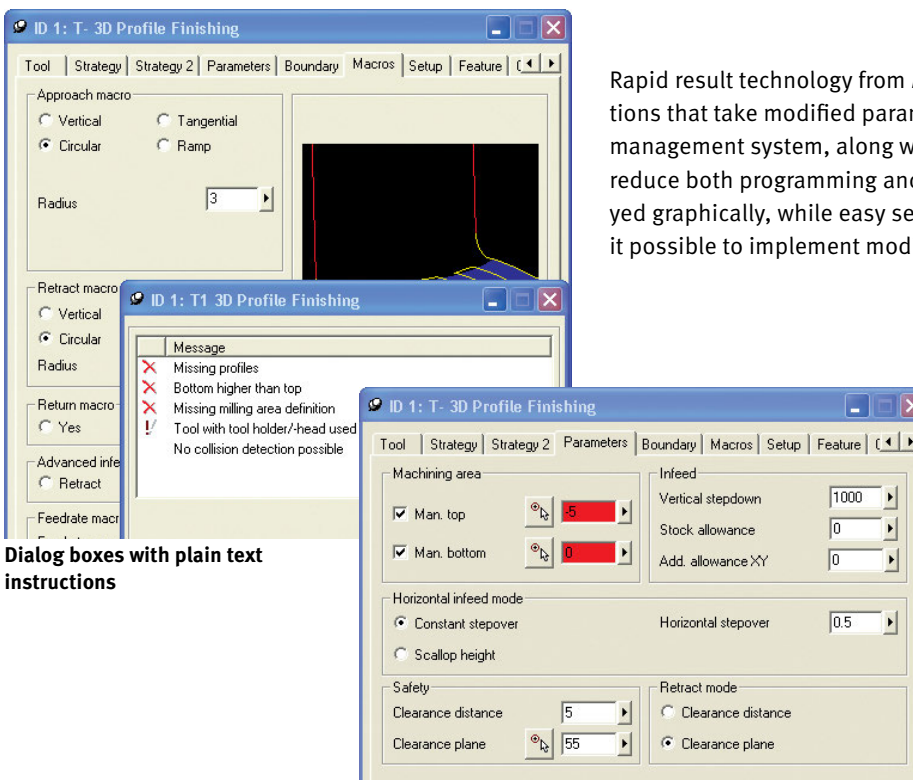

Dialog boxes with plain text instructions

Rapid result technology from *hyperMILL*® integrates automated functions that take modified parameters into account. A clearly arranged job management system, along with descriptions of problems and errors, reduce both programming and input errors. Machining status is displayed graphically, while easy setup, change and copying operations make it possible to implement modifications and variations very quickly.

Erroneous entries are marked

## Job list

→ Parallel calculation and programming, structured procedures and job storage

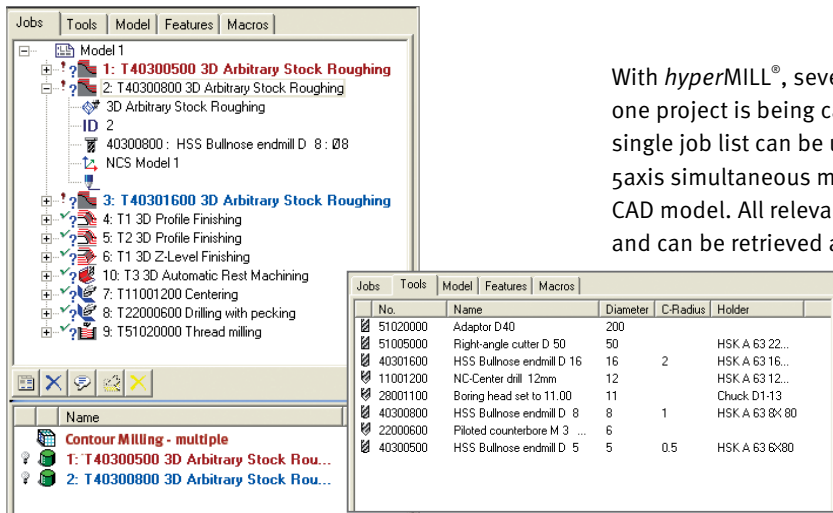

Job list with stock management

Tool list

With *hyperMILL*<sup>®</sup>, several projects can be open at the same time – while one project is being calculated, another one can be programmed. A single job list can be used for all machining strategies, from turning to 5axis simultaneous machining. The job lists are stored directly in the CAD model. All relevant data is automatically integrated and linked and can be retrieved at any time.

## Compound job

→ For well-structured job lists

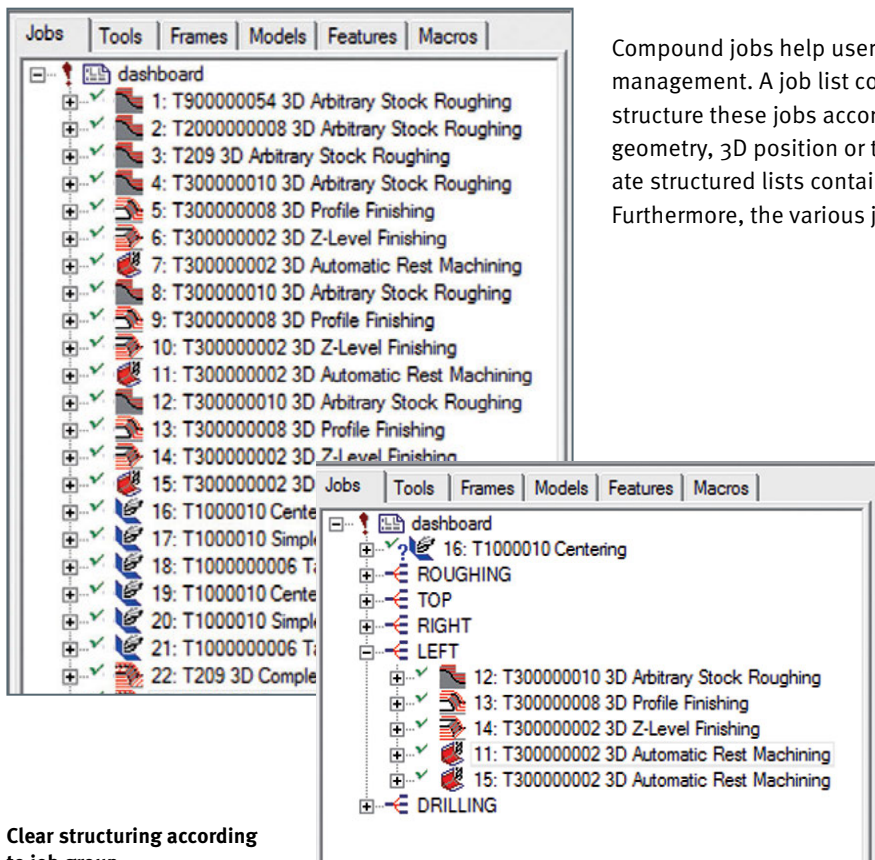

Compound jobs help users to improve their project organisation and management. A job list consists of several compound jobs. Users can structure these jobs according to aspects such as machining process, geometry, 3D position or tool orientation. Thus, it is possible to create structured lists containing many hundreds of programming steps. Furthermore, the various jobs can be shown or hidden as a group.

## Associative programming

### → Time-saving programming with associative copies

This functionality allows users to work more flexibly and quickly edit common machining strategies where only few parameters differ across several steps in a job.

Associative jobs permanently link all parameters with an original reference job. Changes to the reference job are automatically copied to the associated jobs. Any individually definable parameter for a job step can be unlinked from the template by a simple mouse click so that it can be defined differently for this job step.

All parameters that have been unlinked from the job template are displayed in a separate window of the job step where they can be edited.

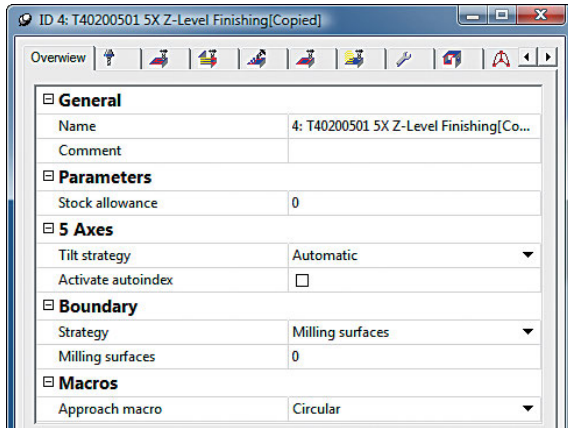

Input screen

## Parameter programming

### → Flexible changes and fast variant programming

Programming with parameters enables the description of dependencies and consequently a rational modification with user-defined variables. This makes it possible to quickly implement variations and changes.

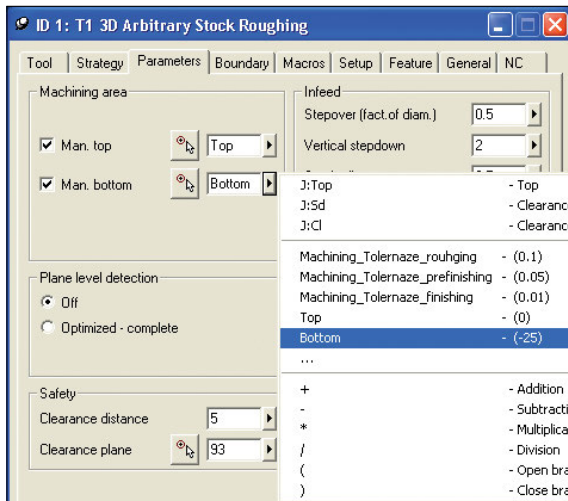

Application of variables

## Defining zero points

### → Customising aspects such as positional tolerances or multiple clampings

By defining zero points, positional tolerances and positions can be flexibly and transparently customised to current requirements. Each defined zero point is assigned a unique ID, and during post-processing this unique ID is translated into a corresponding NC code by means of a zero point table. This feature also allows the definition of multiple zero points.

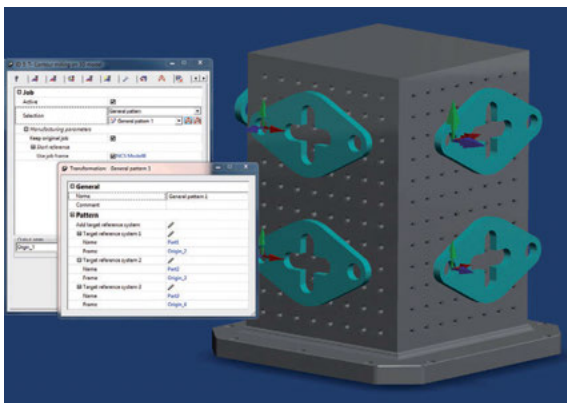

The new zero point appears as an entry in the frame browser.



## Global editing

→ Fast and easy editing across within multiple jobs

*hyperMILL*<sup>®</sup>'s user interface offers additional options to edit parameters through several jobs simultaneously. Next to central parameters such as surface, depth, allowance or infeed, various other geometry selections such as milling or milling surfaces and even macros can be changed within multiple jobs.

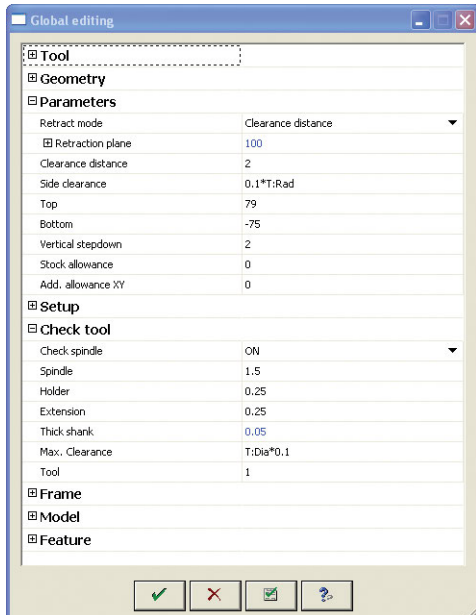

Editing screen

## Extended setup

→ Improved management of data and files used in *hyperMILL*<sup>®</sup>

This function simplifies the handling, entry and configuration of directories containing essential *hyperMILL*<sup>®</sup> data such as postprocessor information, machine definitions and NC files. When saving a CAD model, a backup copy can be created automatically. The storage location and number of backup copies are freely definable.

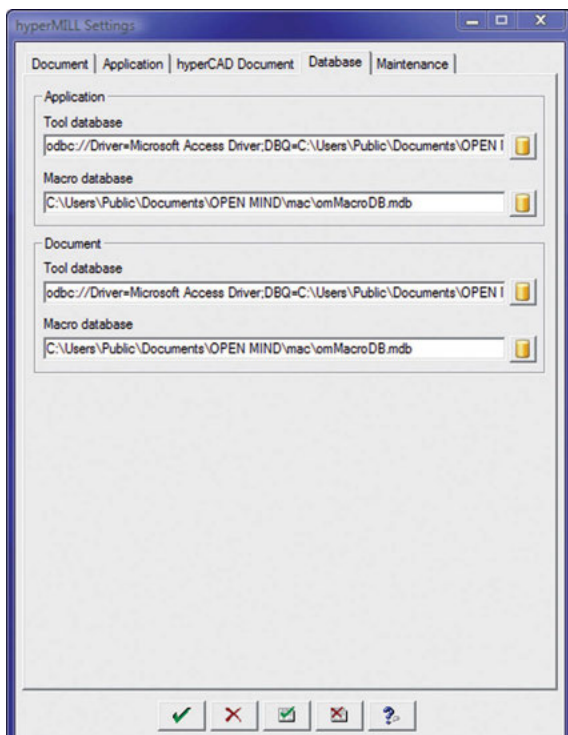

Setup definition



## 2D strategies

*hyperMILL*® enables the efficient programming and processing of typical 2D tasks. High-performance 2D contour milling, intelligent feature technology and the support of controller-specific NC formats are just a few of the reasons why.



## Face milling

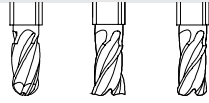

→ Large surfaces

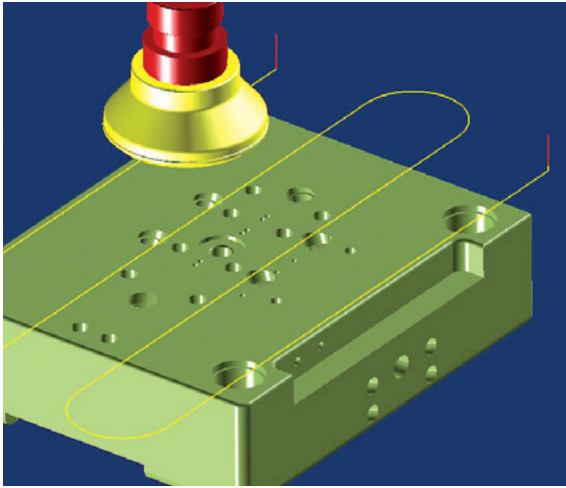

Zigzag mode with filleted path links

With the face milling strategy, flat areas can be machined quickly and simply in one-way or zigzag paths. This allows several independent surfaces to be machined in a single operation.

## Pocket milling

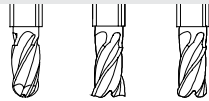

→ Open and closed pockets with or without islands and circular or square pockets

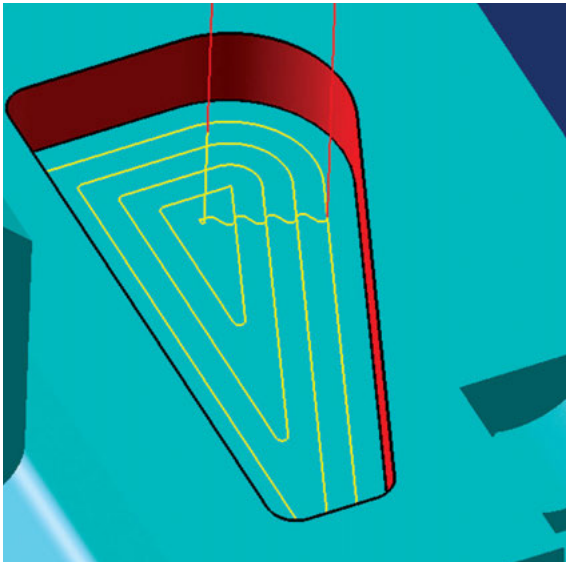

Minimised number of rapid movements and dwell time

In this way, any pocket can be machined, even if it includes islands and additional pockets with various heights and depths. This strategy always seeks a start point where the plunging occurs outside of the material. If this is not possible, a stepdown is made directly in the material via a ramp or a helix, depending on the type of milling tool and setting. This strategy also supports canned cycles for round and square pockets.

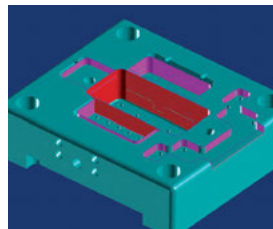

Automatic feature recognition

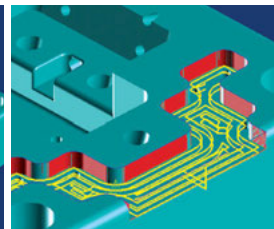

Complete machining of the bottom

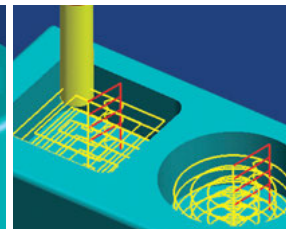

Supports 2D controller cycles

## Contour milling

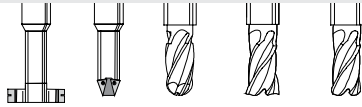

→ Optimised machining of open and closed contours

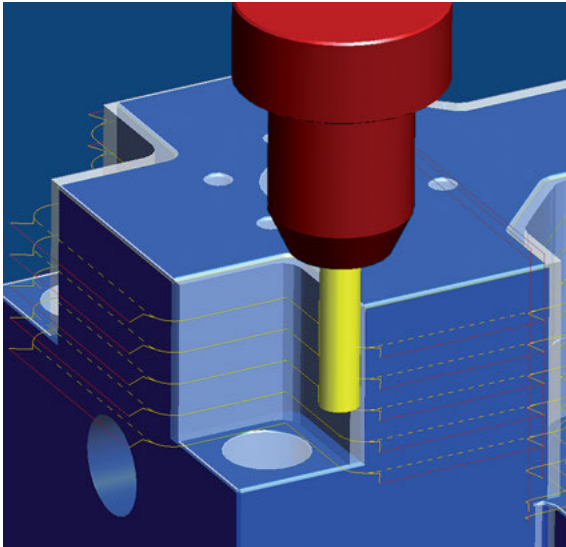

The contour milling strategy is used to machine complex contours. A selection can be made between centre path and contour path, including G41/G42 tool path compensation. *hyperMILL*® automatically prepares the contours, detects bottlenecks and self-cuts and prevents collisions with defined safe zones.

The “Automatic orientation”, “Fast travel optimisation” and “Contour sorting” functions assist users while programming models with multiple contour areas or for machining automatically detected pocket features.

The automatic search feature for starting points can be used together with intelligent approach and retract macros to ensure that infeeds and transition movements are always performed in the most suitable areas for the technology in use. Other functions such as automatic vertical step down, multiple infeeds and definition of additional finishing offsets allow users to make effective and reliable use of their tools.

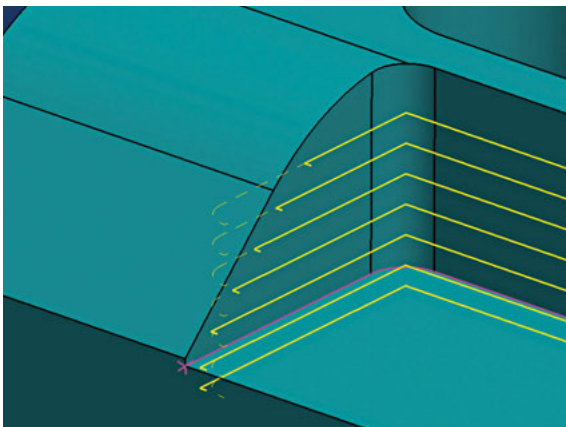

Machining with multiple Z-infeeds  
2D trimming against the model...

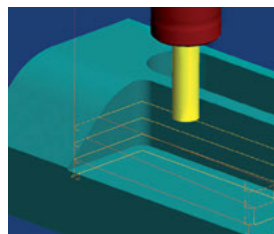

...with automatic cut division

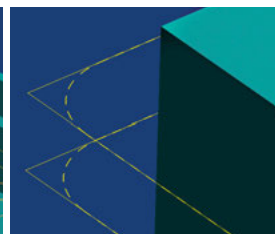

Fillet outside edges...

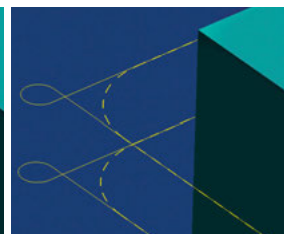

... with extended edges

## Optimisation functions



Checking self-cut, bottleneck and collision

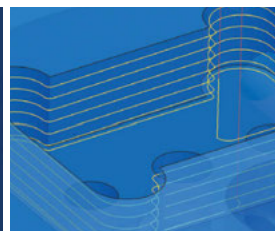

Spiral machining down to the bottom

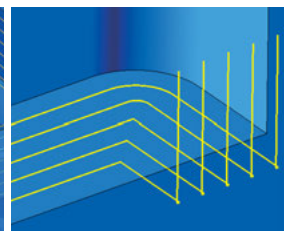

With multiple lateral infeed

## Playback

### → Simple creation of toolpaths

Toolpaths can be generated manually by moving the tool across the model with the mouse. Once defined, *hyperMILL*® performs a collision check for the tool against the model. If a collision is detected, the software modifies the tool paths to place them at collision free points on the model.

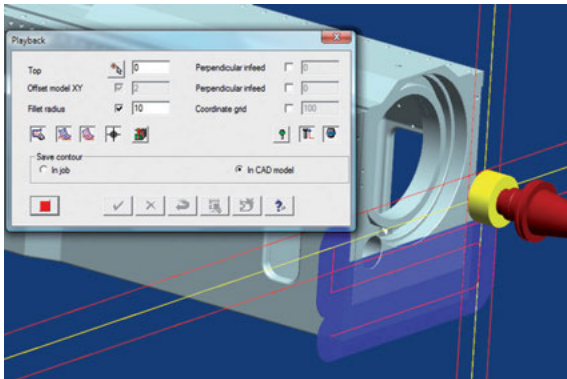

Easy generation of NC toolpaths

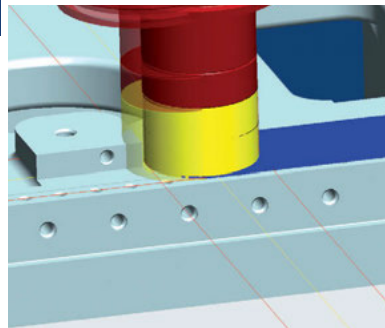

With collision checks

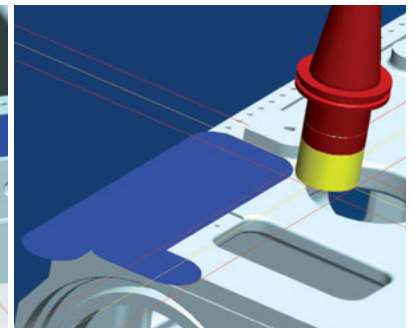

Reliable programming of machining processes

## Rest machining

### → The machining of residual stock

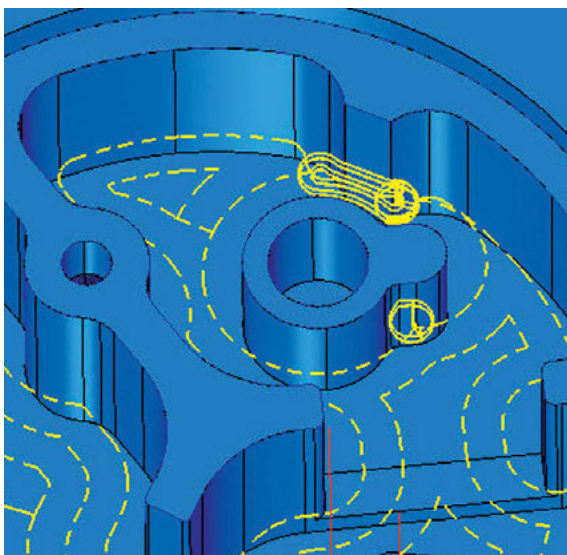
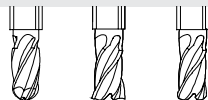

Residual stock machined with contour or pocket machining cycle

For areas not accessible using large tools in 2D contour and pocket machining, this strategy calculates separate tool paths for small milling tools. This referencing approach automatically detects all areas that have not been processed and machines them. It detects not only areas within a contour, but also between different contours.

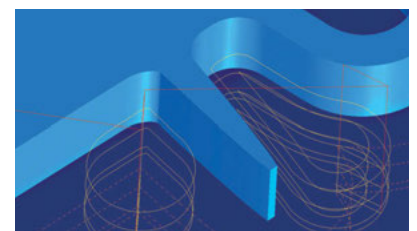

Tangential infeed for best surfaces

## Drilling

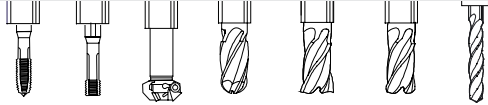

→ Centering, simple drilling, deep drilling, drilling with chip break, reaming and boring, thread milling and drilling, deep hole drilling

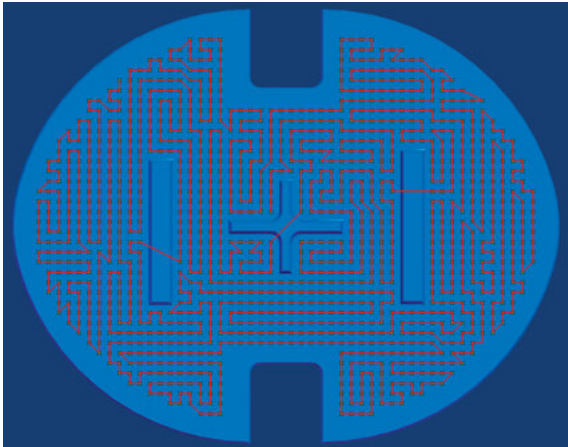

Drill optimisation: shortest path

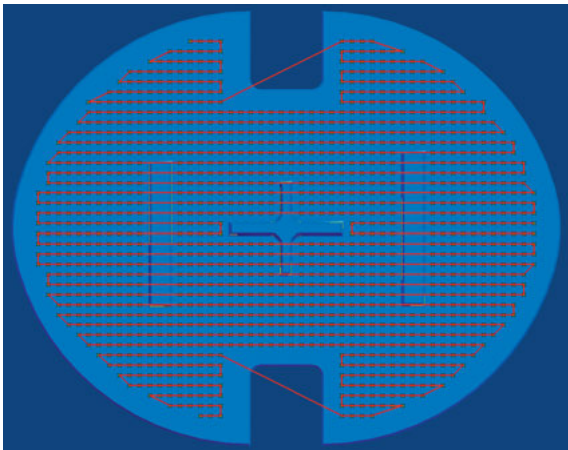

Drill optimisation: X-parallel

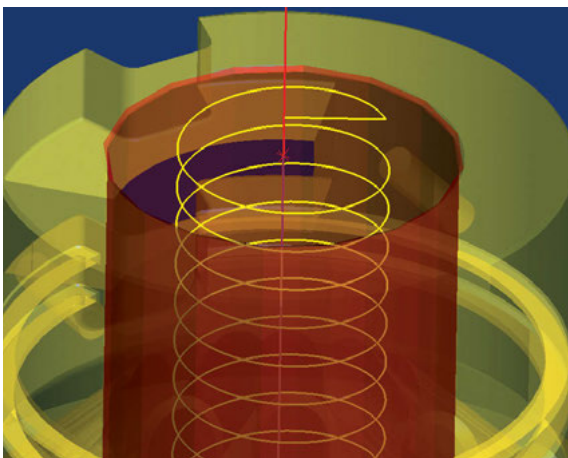

Helical drilling with freely definable pitch

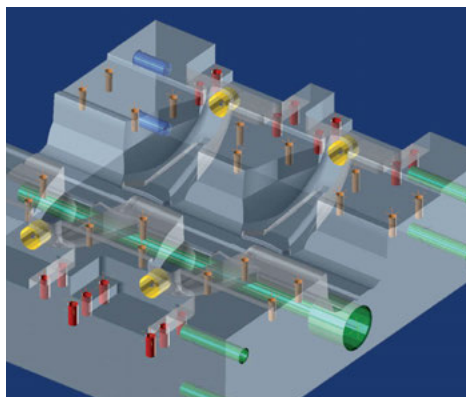

Programming with feature recognition

The strategies and functions for drilling enable highly efficient programming, especially in conjunction with feature and macro technologies. Depending on the machine controller and available options, the postprocessor will support canned cycles, subroutines, point lists or will output simple G1 movements.

In helical drilling, the milling tool cuts into the part in a spiral motion. The user can freely define the pitch of the spiral, within the limits of technological reason. Internal and external threads are produced by thread milling. The option of deep hole drilling enables the milling of very deep holes.

## Optimised simple drilling

### → Drilling deep holes

Complex deep holes with various steps and cross-holes can be programmed separately using *hyperMILL*®. The infeeds, drilling speeds and coolant can be controlled separately for different areas and geometry elements such as guide bushings, pilot holes or cross-holes. Here, the strategy detects cross-holes in the specified stock.

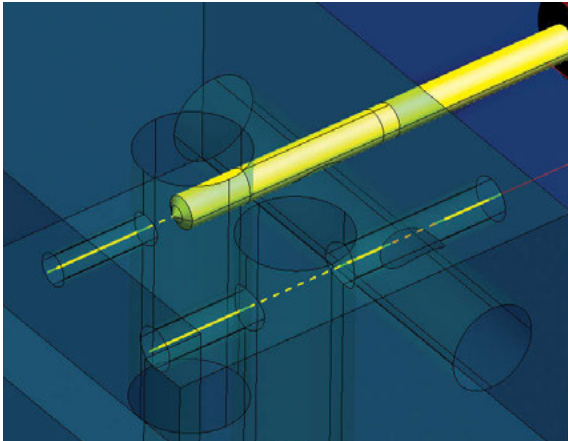

Automatic detection of cross-holes

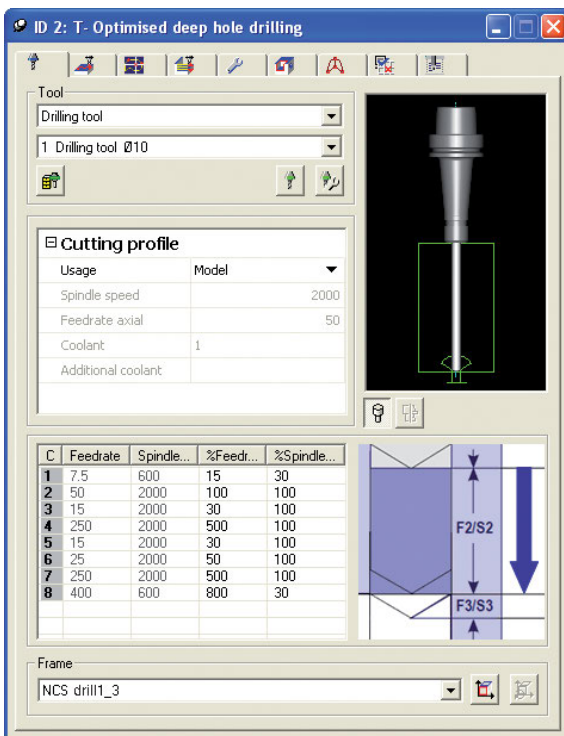

Input screen for optimising process

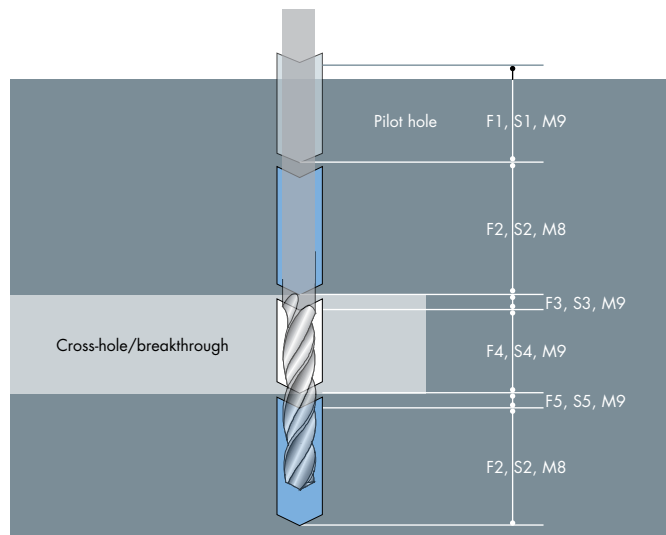



## 5axis drilling

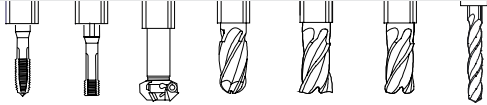

→ **Drilling with different tool angles in a single operation with optimised toolpath lengths**

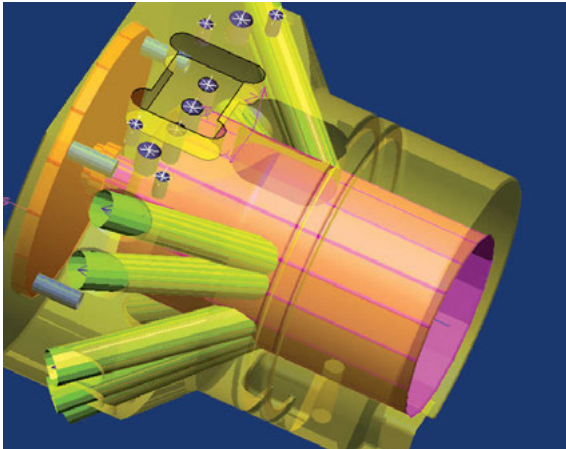

**Feature-supported 5axis drilling**

The 5axis drilling function is used to simply and automatically program drilling operations with different tool inclinations in a single operation. An automated function calculates the tool inclination and connects all reference points of drilling operations for the best possible path.

Within certain drill patterns, the clearance plane can be defined very close to the part, and the tool need not repeatedly go to a safety position. For the machining of different drill patterns with different tool inclinations, additional retraction positions can be defined that reduce the path length. The movements between the drill holes and the movements between the individual machining planes are automatically checked for collision against the model. If collisions are detected, the cycle automatically positions the tool on a collision-free plane.

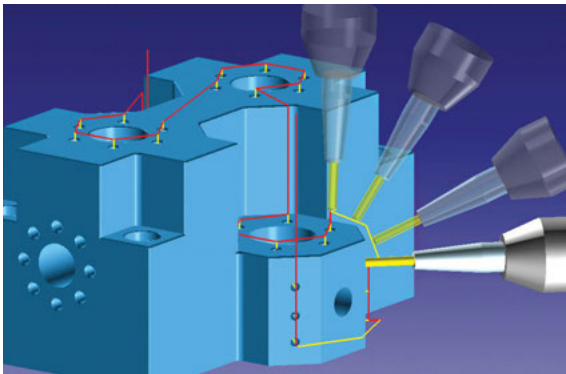

**Optimised tool path between holes using different tool inclinations**

Drill hole optimisation reduces the paths travelled between the drill holes in one plane. If a rotating axis movement is required, the user can determine whether the A-axis or C-axis is used first. Furthermore, users also have the option of using the Z-height as a sorting criterion.

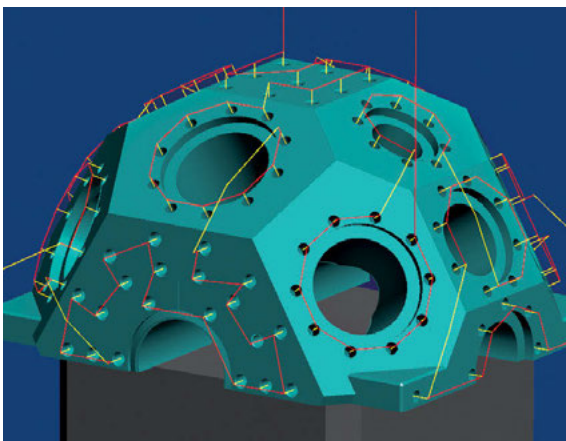

**Optimised drilling for B-axis**

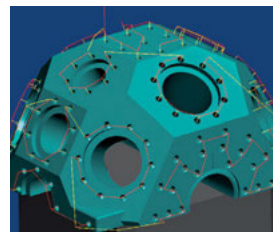

**Optimised drilling for C-axis**

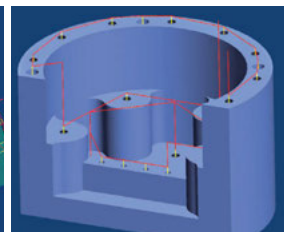

**Optimised drilling for Z-level**





## 3D strategies

*hyperMILL*® offers a broad spectrum of 3D strategies. Intelligent add-ons generate optimised machining programs for better surfaces and shorter machining times.

## Roughing

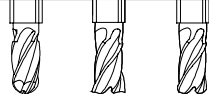

→ Optimised and reliable roughing, based on current stock calculation

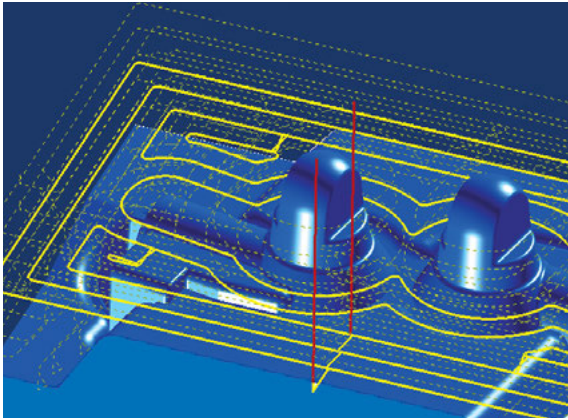

Contour-parallel machining

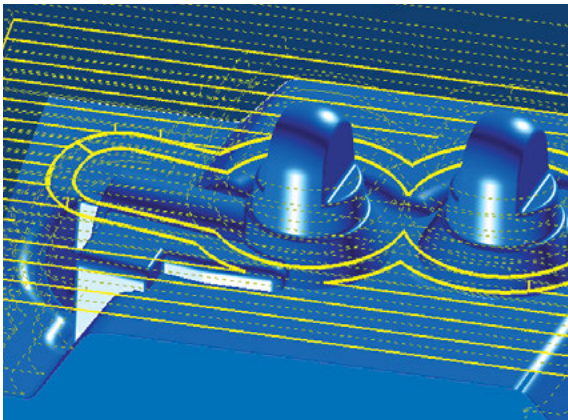

Axis-parallel machining

All depths may be machined by contour offsets from model or parallel to a specific axis. The stock may be generated from surface or solid models, from extruded or revolved profiles or as a result of any previous machining process. Due to automatic stock recognition, the remaining stock areas are easily detected and machined from any direction.

By defining minimal material removal, milling paths are optimised, and very short and redundant movements are avoided. The 'Force contour cutting' parameter enables the use of this strategy for preliminary finishing and rest machining. As a result, a uniform offset is already achieved during roughing. The plunge movements are optimised by entering the tool parameters for core diameter and core height. Here, the infeed is calculated automatically and adapted to the tool.

Collisions are checked against the stock model and part model. When a possible collision is recognised, the user can select to stop the process or to adjust the toolpath laterally and continue the operation at a greater depth.

## Optimisation functions

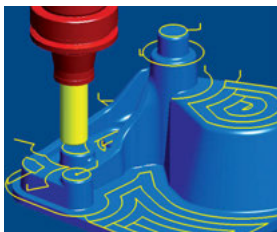

Automatic plane detection

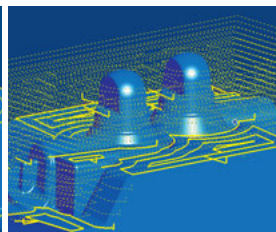

Machining entire part with a constant allowance

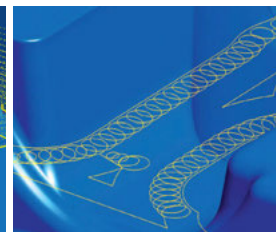

Avoiding full cuts

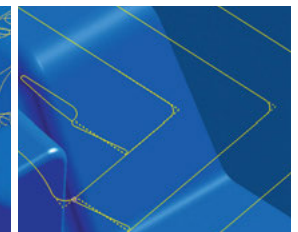

Filleting corners

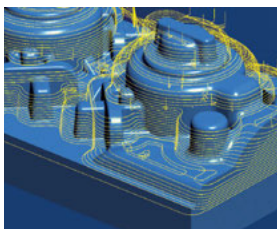

Use for preliminary finishing

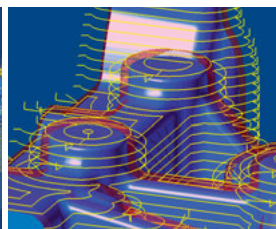

Cast offset roughing

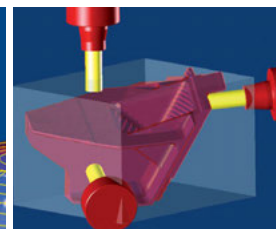

Rest machining from various directions

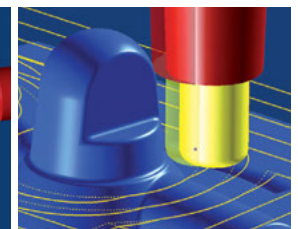

Lateral offset to prevent collision with shank and holder

## Finishing: Profile finishing

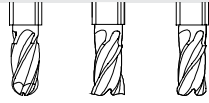

→ Milling close to contours

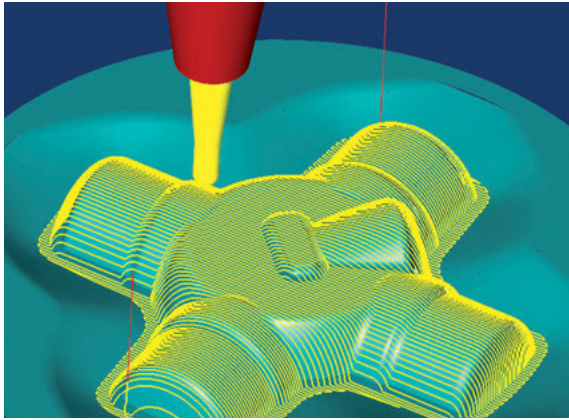

Profile finishing enables collision-free machining along surfaces and surface groups. Such machining offers a number of strategies and optimisation functions in order to individually machine complex areas and to adapt NC paths to the special properties of a model.

**Axis-parallel machining**

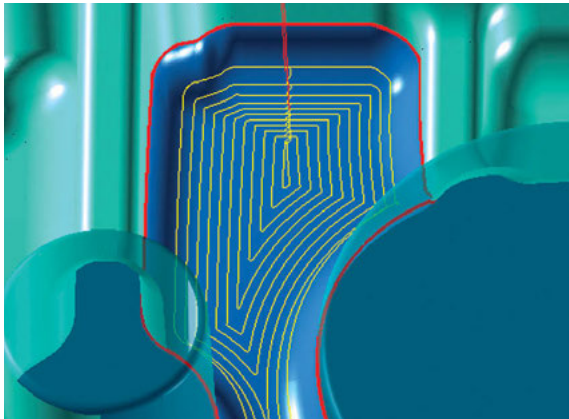

**Contour-parallel machining**

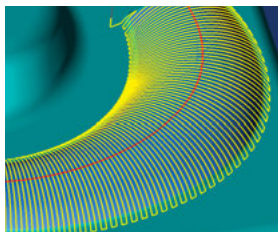

**Tool path 90° to guide curve**

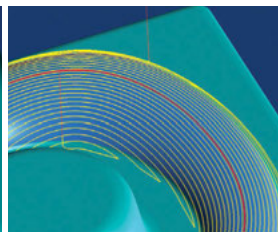

**Tool path lateral as offset to guide curve**

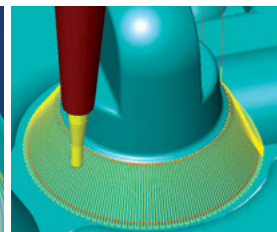

**Cross-flow tool path motion between two guide curves**

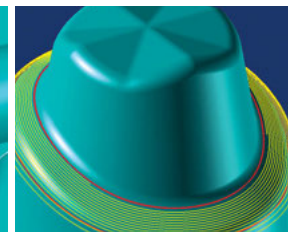

**Tool path motion flowing between two guide curves**

## Optimisation functions

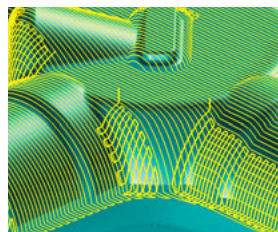

**XY optimisation**

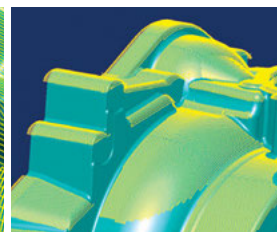

**Machining of only flat areas**

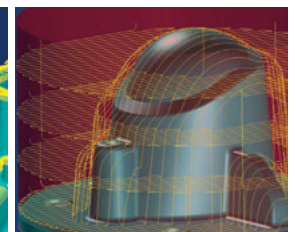

**Profile roughing**

## Finishing: Z-level finishing

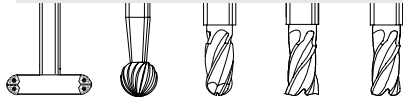

→ For steep areas

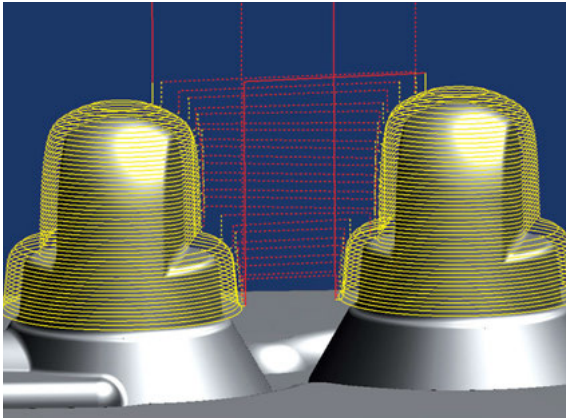

Machining is executed close to the contour on planes with a constant Z-infeed. For optimal machining, this strategy offers several machining functions and optimisation parameters. For closed milling areas, the “spiral” strategy achieves the best surfaces and machining process.

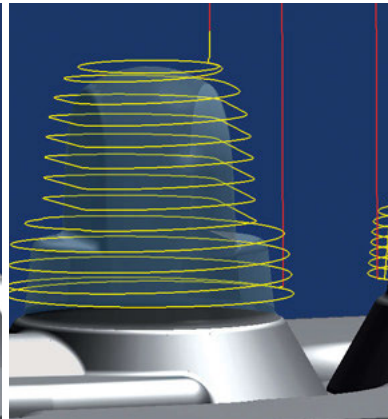
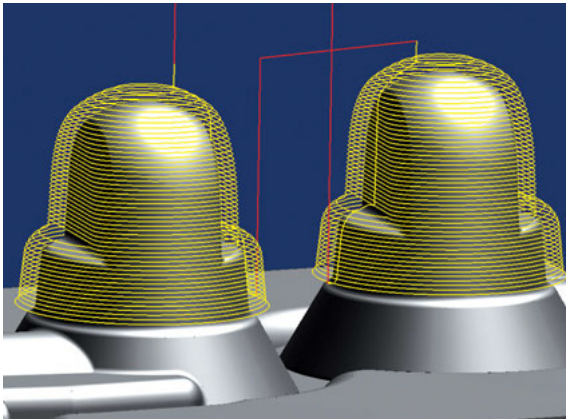

Plane- or pocket-based machining

Spiral machining of closed milling areas

Zigzag machining of open milling areas

## Optimisation functions

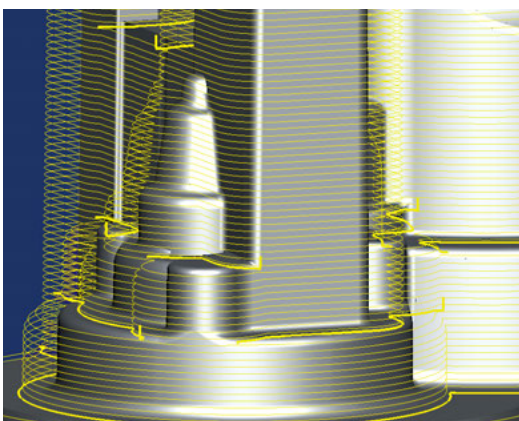

Plane level detection

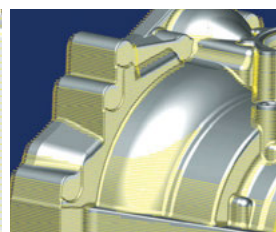

Machining steep areas

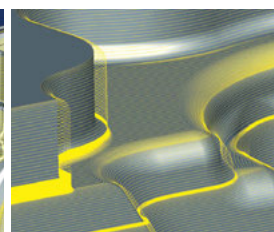

Automatic Z-infeed adjustment

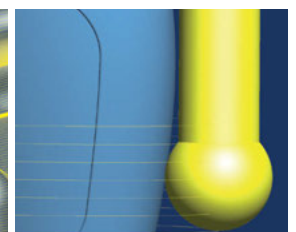

Undercut machining with lollipop or woodruff cutter

## Automatic rest machining

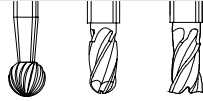

### → Rest machining

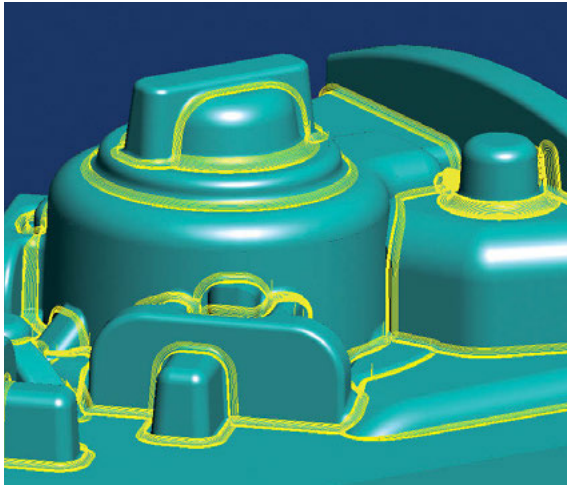

Rest machining of incompletely machined areas

In the finishing cycle, automatic rest machining detects incomplete machined areas. After defining the reference tool and the machining area using the boundary function, the necessary rest machining is automatically executed.

A rest material area that has not been machined due to potential collisions can be used as a reference for a subsequent machining step with modified tools (e.g., longer tool lengths). This ensures that only the areas that could not be completed during the first step are machined in this next one.

The machining strategies for cavities make it possible to create grooves, ribs, and deep or narrow slits in a single machining step. Deep areas containing large amounts of material can be cleared completely and effectively using a constant infeed.

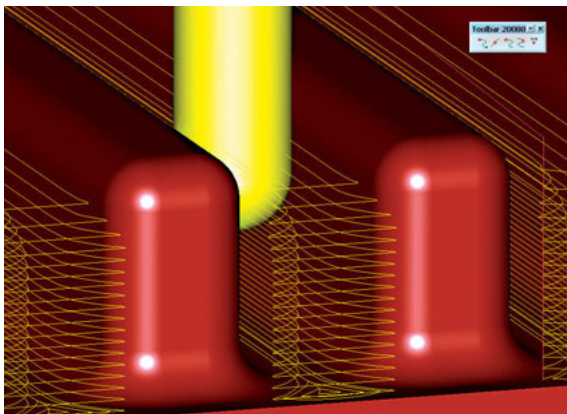

Milling grooves

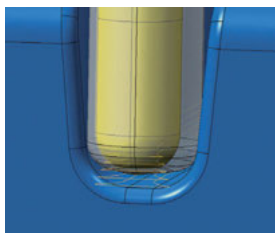

Bullnose endmill as reference tool

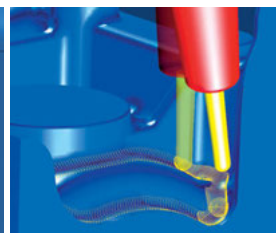

Previous job as reference

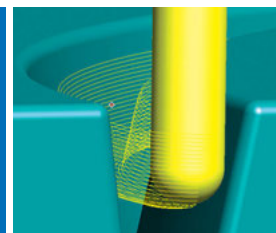

With definition of machining depth

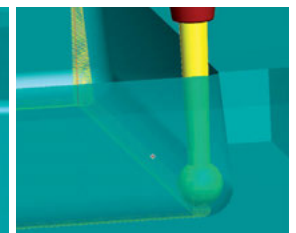

Undercut machining with lollipop mills

## Optimisation functions

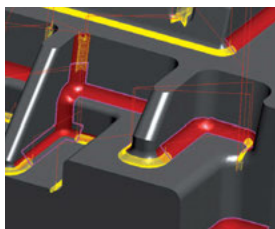

Visualisation of non-machined area



Machining of only steep areas



Machining of only flat areas



Pencil milling

## Complementary strategy: Complete finishing

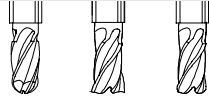

→ Electrodes and prismatic parts

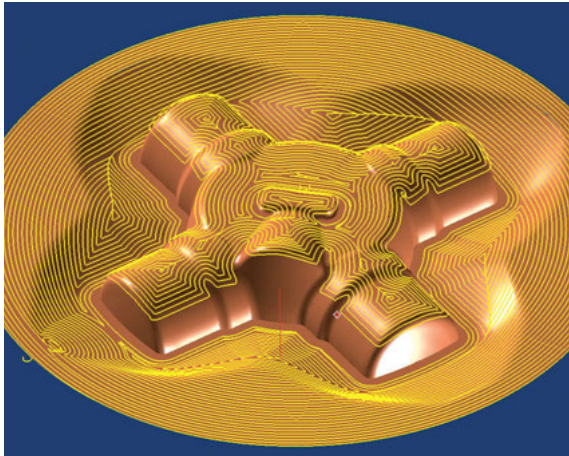

Slope machining

By combining Z-level finishing and profile finishing, this strategy can automatically adapt machining to the requirements of individual regions of a model. In accordance with the defined slope angle, machining is divided automatically between steep and flat areas, both of which can be processed in a spiral pattern.

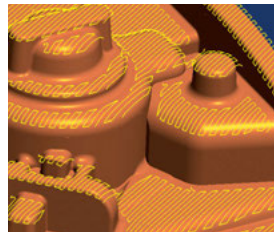

Parallel machining paths for flat areas

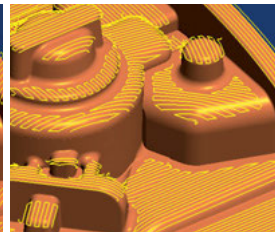

Automatic alignment based on longest pocket dimension

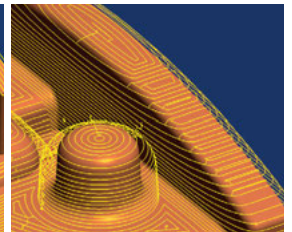

Pocket-shaped clearing when there are large distances between paths

## Complementary strategy: Equidistant finishing

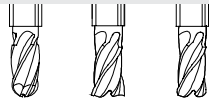

→ Models with flat and steep areas

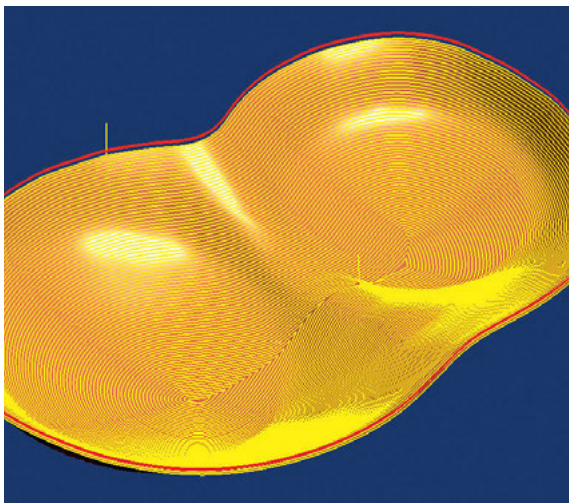

Machining with closed guide curve

By defining one or two guide curves, the strategy calculates the milling paths parallel to the indicated curve. Here, the distance between paths is not calculated in the XY plane, but rather always on the surface. In this way, flat and steep areas can be machined in a single operation with the same surface quality.

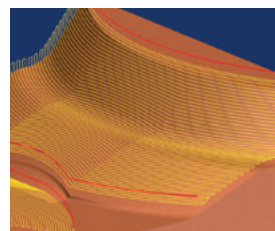

Machining between two open guide curves

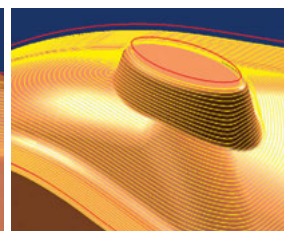

Spiral machining between two guide curves



## Complementary strategy: ISO machining

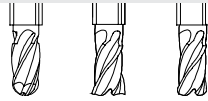

→ **Precise machining of individual surfaces and transition radii with uniform path distances**

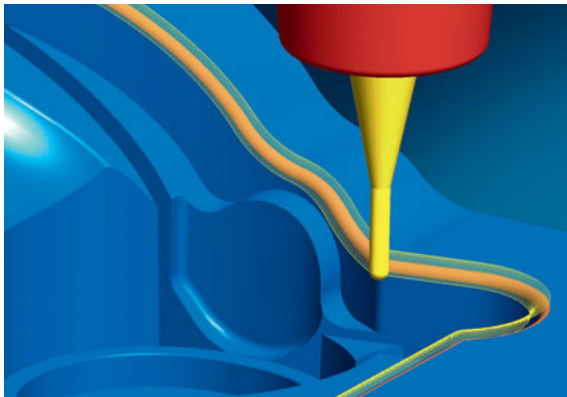

ISO machining with global alignment

ISO machining can be performed with global alignment or by defining the direction of machining with ISO curves (U and V). When machining with ISO alignment, the milling paths run along the ISO curves (U and V). The U and V curves of contiguous surfaces are automatically aligned. This facilitates machining across several surfaces without retracting the tool. The machining area can be limited by a boundary. The global alignment strategy automatically determines the optimal milling direction based on the longest boundary of the selected surface. The user defines whether the machining proceeds diagonally or freely to the direction of machining. Multiple surfaces can also be selected here. In addition, spiral machining in one step without a dwell point is possible.

## Complementary strategy: Freepath machining

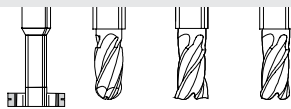

→ **Simple engraving and edge milling**

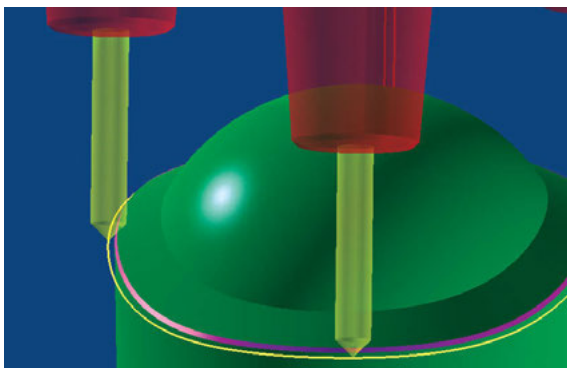

Controlling the tool path with guide curves

During curve machining, the cutter follows a defined contour. This strategy can be used for especially quick engraving on a planar or curved surface, or for deburring, chamfering or trimming 3D edges.

## Complementary strategy: 3D rework machining

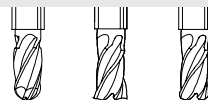

→ **Editing of tool paths to prevent collision**

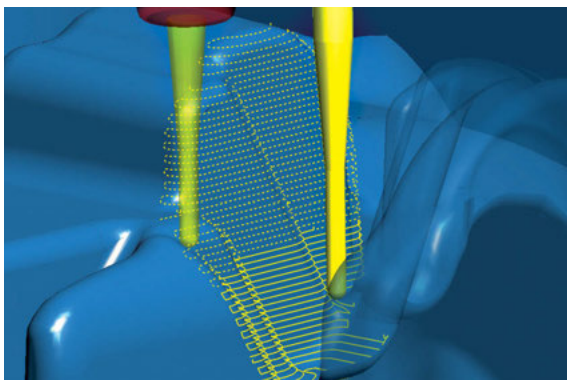

With the aid of rework machining, tool paths from a reference operation with other tools and modified tool inclinations can be output without recalculating the path, and checked for collisions. This can be done on the complete tool path as well as with path sections that have been excluded in the reference operation in order to prevent collisions.

**Outputting of complete tool paths with optimised positioning**



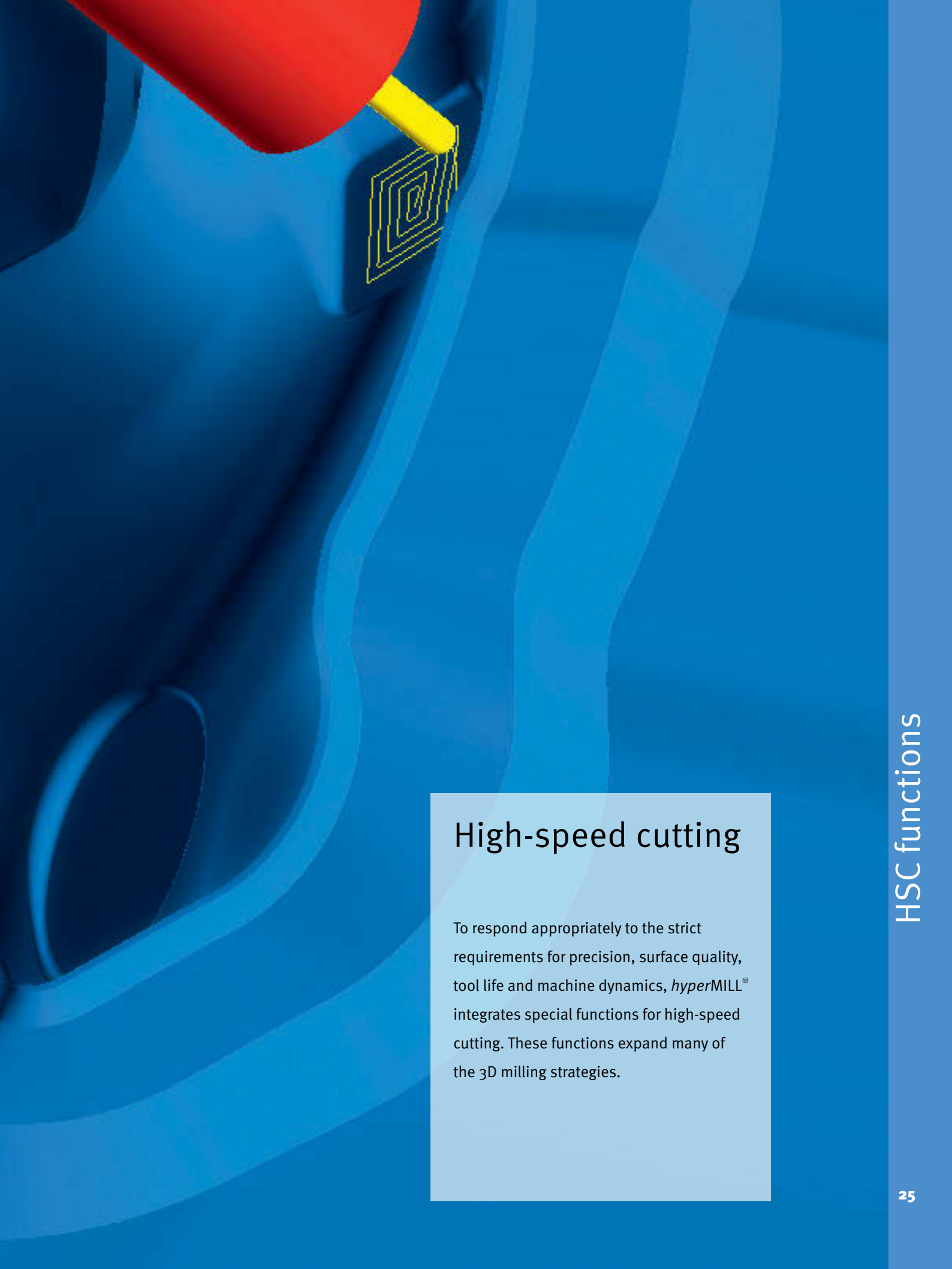

## High-speed cutting

To respond appropriately to the strict requirements for precision, surface quality, tool life and machine dynamics, *hyperMILL*® integrates special functions for high-speed cutting. These functions expand many of the 3D milling strategies.

## Filleting of corner radii

→ For high feed rates with continuous machine movements

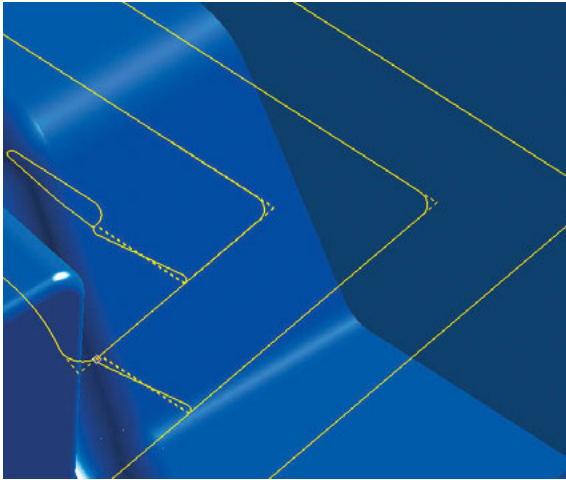

Roughing

For smoother machine movements and better cutting behaviour, interior corners can be filleted. Tool path filleting is available as an additional function with, among others, roughing, Z-level finishing, profile finishing and automatic rest machining.

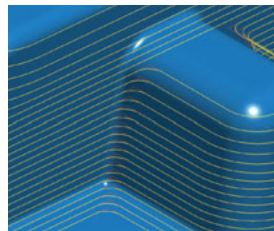

Z-level finishing

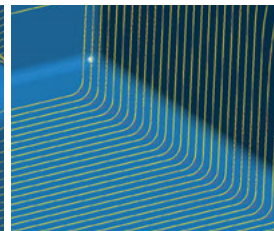

Profile finishing

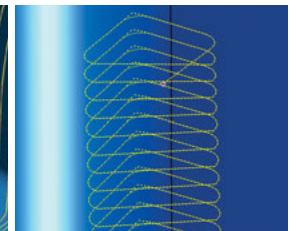

Rest machining

## Smooth plunging

→ Optimal cutting conditions for constant cutter loads

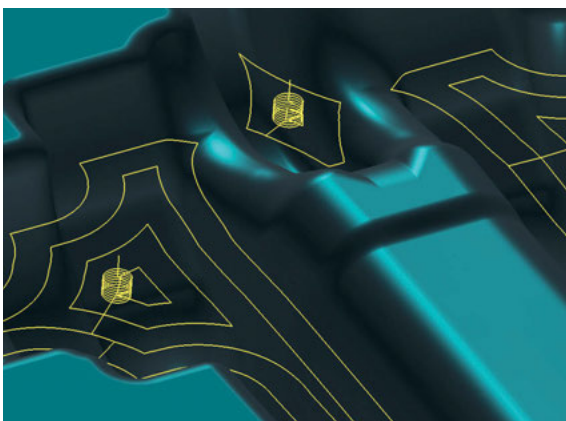

Plunging via helix path

With axial infeed, an optimal feed rate can be maintained and the tool can be protected using a helix or a linear ramp.

## Smooth infeed

### → Optimised tool movement between tool paths

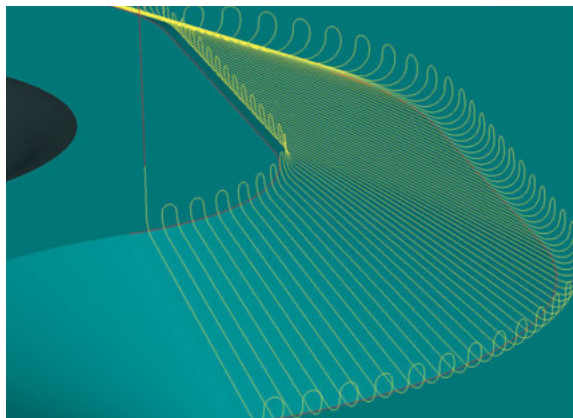

Smooth approach and retract movements

Approaches and retracts, as well as the transition between individual paths, can be filleted. During the process, the tool can also be raised from the surface in a smooth movement.

## Spiral machining

### → For high feed rates and optimal cutting conditions

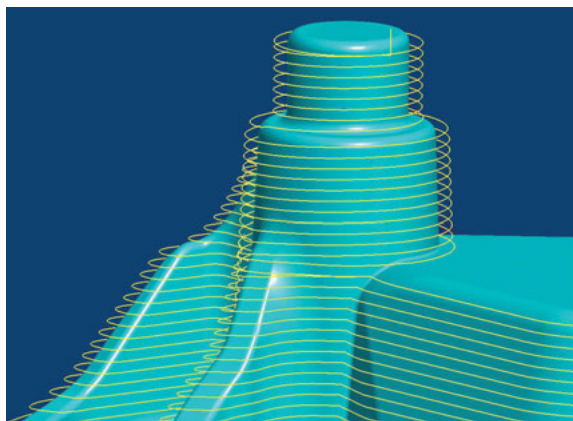

Continuous spiral tool path

Machining is optimised for Z-level and equidistant finishing, for automatic rest machining and for machining closed curves with a continuous tool path – including complete or near-complete spiral infeed.

## Avoiding full cuts

### → Even tool load and averting tool breakage while milling grooves

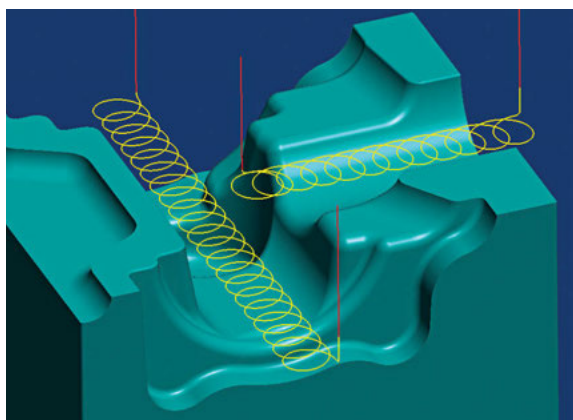

Trochoidal machining

Trochoidal machining is the best strategy when milling grooves in the HSC area. Spiral step-over movements allow larger chip loads and reduce the time when machining larger depths of cut.





## 5axis machining

For demanding geometries such as deep cavities, high steep walls and undercuts, 3D machining is not possible because of collisions – or it is only possible with long tools. Machining these areas requires precisely defined milling areas and many different tool inclinations, which can be accomplished without collisions using 5axis machining. Depending on the geometry and machine kinematics, you can select between 5axis machining with a fixed tool inclination, automatic indexing or simultaneous machining. Larger, slightly curved surfaces and geometries that follow leading surfaces or profiles can also be efficiently milled using 5axis machining.

## Multi-axis indexing with fixed tool inclination

→ All 2D machining jobs from different sides



Shifted and tilted workplane

This function enables the machining of parts from different directions with one setup. It shifts and tilts the workplane for machining. The direction of machining corresponds to the orientation of the tool. Programs can be transformed and copied, even on multiple workplanes, without additional job calculation.

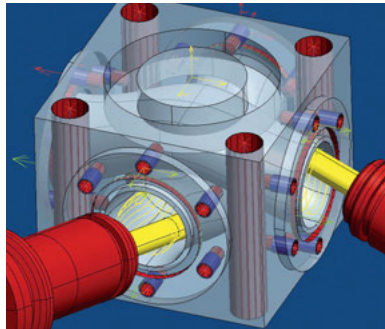

With program part repetition

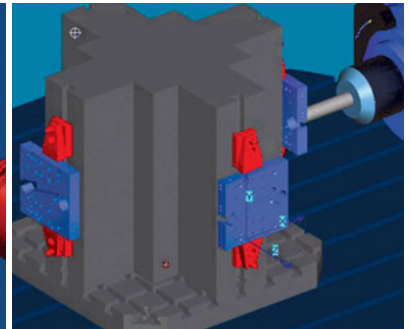

Program part repetition with multiple setup

## Milling with fixed option 3 + 2

→ All 3D machining operations with the tool pivoted relative to the direction of machining

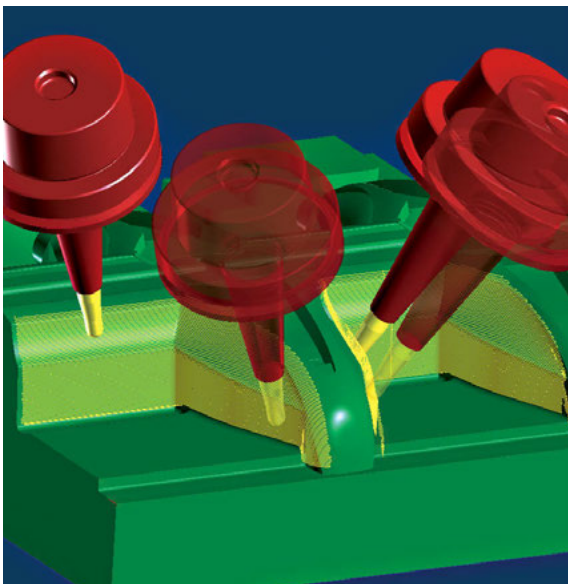

Programming with fixed tool inclination

Cutting areas can be programmed from a single machining direction with different tool inclinations and free of collision. They can be easily kept separate, with no overlapping or gaps occurring. The course of the paths for neighbouring areas and the appearance of the surface can be precisely determined. In addition, this strategy ensures that all areas including details are completely calculated.



## Automatic indexing

### → Automated 3+2 milling as an alternative to 5axis simultaneous machining

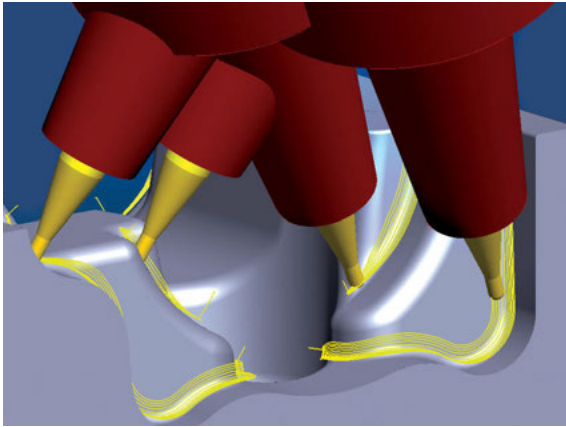

Automatic search for fixed tool inclination

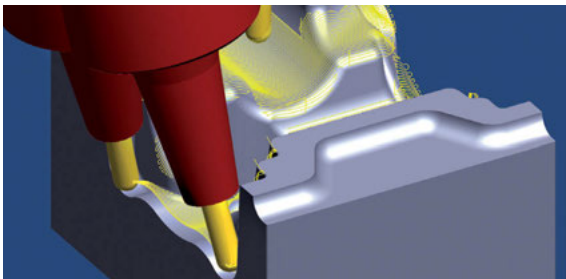

Profile finishing with optimised tool inclination

Areas that require multiple tool angles for machining are programmed and milled in a single operation using automatic indexing. This method automatically seeks a collision-free fixed tool angle for individual milling areas and/or toolpaths. You can choose whether perpendicular (vertical) or angled tool orientations are preferred. With manually defined segment limits, milling areas can also be individually separated. If necessary, 5axis simultaneous machining operations can also be used for local machining. In comparison to complete 5axis simultaneous machining, however, automatic indexing minimises machine movement. This reduces machining times and thus minimises stress on the machines.

If it is not possible to calculate a collision-free fixed tool angle for an area, then, with 5axis rest machining, for example, a subdivision into smaller segments with different tool angles can be performed automatically.

## 5axis simultaneous machining

### → Machining on or near steep walls; alternative to fixed tool inclination or automatic indexing

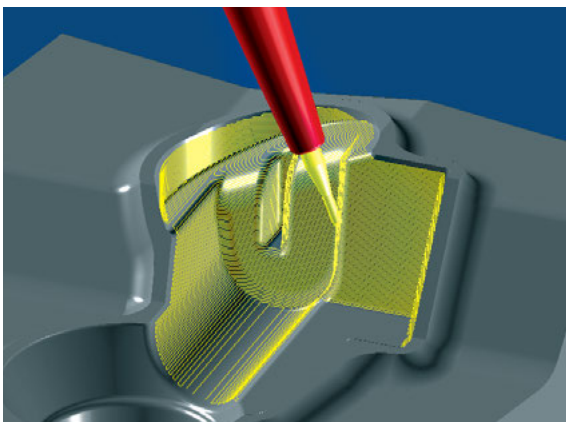

This 5axis machining cycle is the alternative to conventional 3+2 milling. Here a tool tilt to the Z-axis is defined, which *hyperMILL*® automatically changes to prevent collisions. The continuous movement of the tool around the Z-axis is calculated by *hyperMILL*® either fully automatically or as a result of defined guide curve.

#### Fully automatic calculation of tool inclination

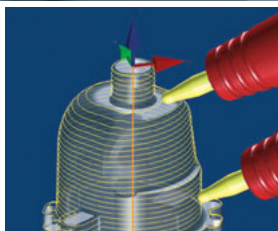

Radial tool alignment to Z-axis

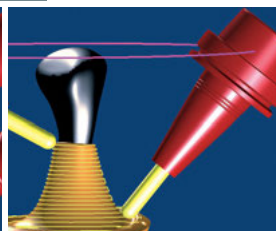

Tool axis always runs through the guide curve

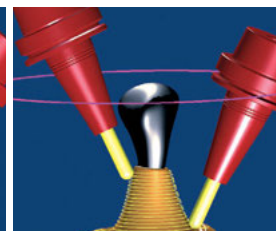

Tool axis runs locally through the guide curve

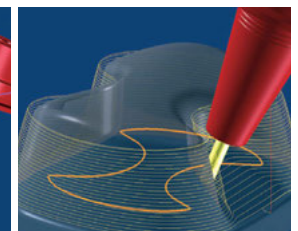

Manual curve for movement only around the Z-axis

## 5axis Strategies for Cavity Machining

→ For difficult geometries such as deep cavities and steep high walls

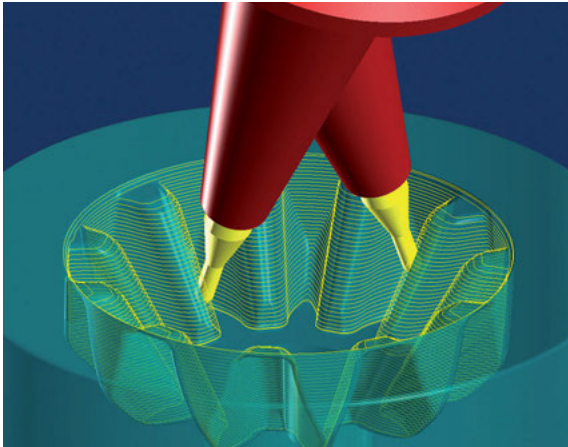

5axis z level Finishing with simultaneous machining

*hyperMILL*® 5AXIS adds 5-axis positions to “z level Finishing”, profile finishing, equidistant finishing, free path milling, rest machining and rework machining 3D strategies. These strategies can now be used for 3+2 milling, automatic indexing and 5axis milling. Thanks to the fully automatic calculation of tool positions, 5axis machining jobs can be programmed as easily as conventional 3D tasks.

5axis “z level Finishing” is used to machine steep surfaces as planes or pockets. Flat areas can be automatically excluded in this type of finishing.

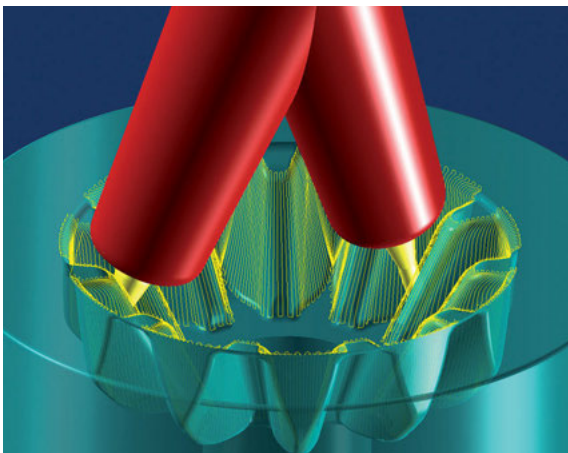

5axis profile finishing with automatic indexing

As with conventional 3D tasks, flat or slightly curved areas can be machined using 5axis profile finishing. 5axis collision avoidance allows you to mill near steep walls using a short tool in a single step. Combined with automatic indexing, steep walls can also be machined in the removal direction of the mould.

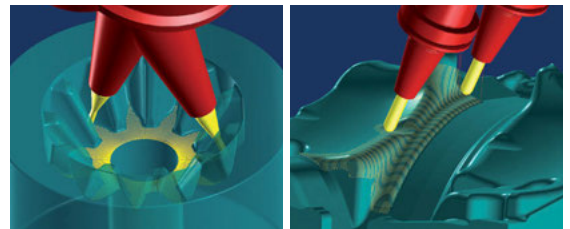

Simultaneous machining

Fixed position

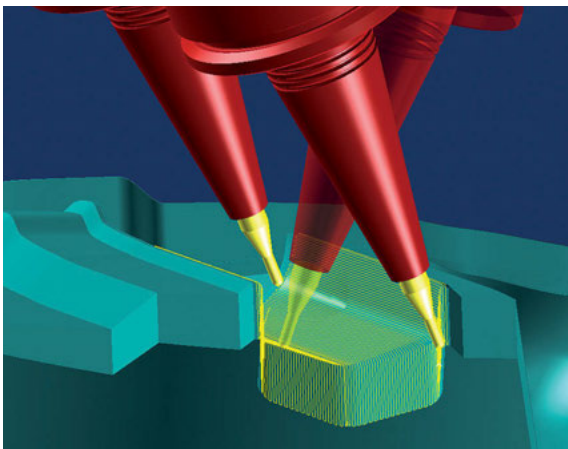

5axis equidistant finishing with simultaneous machining

5axis equidistant finishing allows you to machine steep and flat areas in a single operation. This strategy generates especially smooth transitions between individual tool paths. It helps prolong the lifespan of tools and machines and ensures the best surfaces possible.

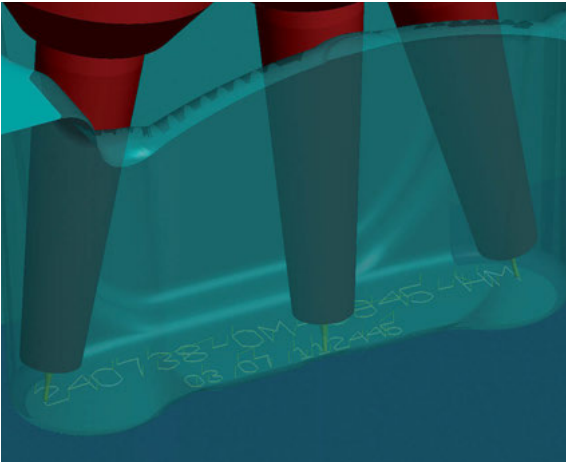

**5axis free path milling with automatic indexing**

5axis curve machining makes it possible to mill engravings without collisions using short tools, even near steep walls.

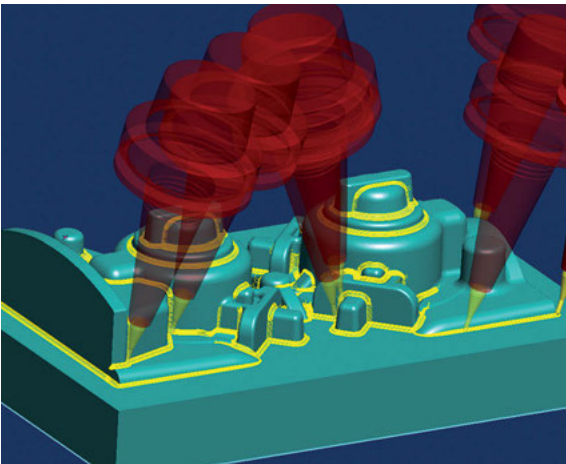

**5axis rest machining with automatic indexing**

5axis rest machining offers all the options of 3D rest machining in addition to the 5axis tool positions. Automatic indexing determines the positions and areas that allow the part to be completely machined in a single operation.

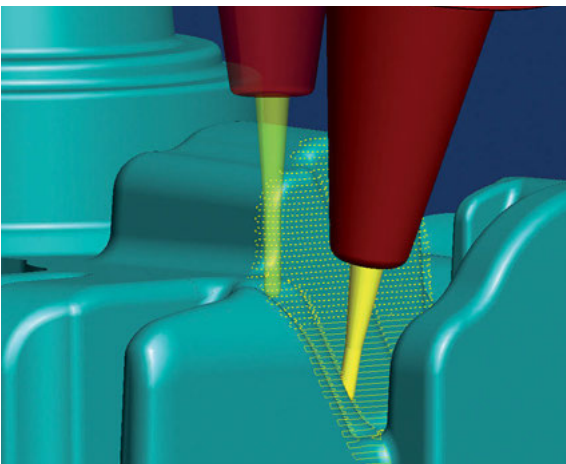

**5axis rework machining with simultaneous machining**

5axis rework machining (editor) is used to convert 3D programs into 5axis programs. It also allows 3D tools that have been excluded due to a collision to be machined as 5axis simultaneous machining jobs or with automatically calculated fixed positions. All 3D and 5axis tool-paths can also be optimised to improve milling results.

## 5axis cutting edge machining

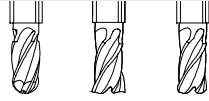

→ Machining of 3D trimming tools

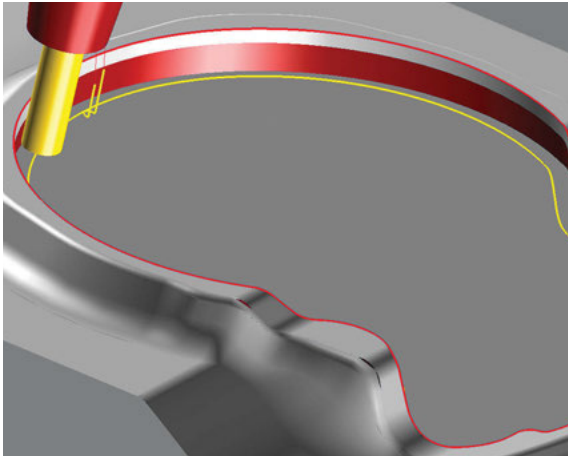

Exact, reproducible machining operations

The strategy enables a fast reproducible machining of cutting edges. The machining job is defined using a reference curve. After selecting the edge and inputting the height and clearance angle, the machining job is calculated automatically.

## 5axis contour machining

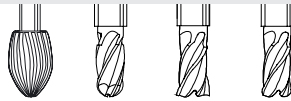

→ Milling grooves, engraving, deburring and chamfering

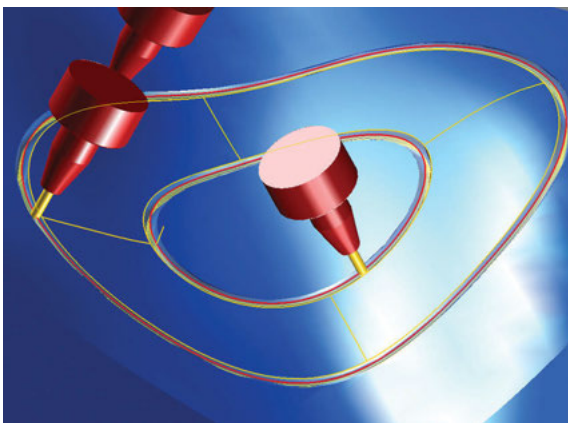

Milling grooves

With this strategy the tool is guided on or relative to a curve with a fixed orientation to the surface. Grooves, chamfers and other similar geometries don't have to be designed in detail. The automatic collision detection and avoidance functions makes programming these machining jobs easy and reliable. If necessary, the tool orientation can also be manually changed for particular areas.

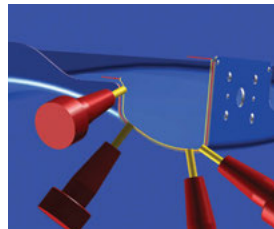

Trimming – perpendicular to surface

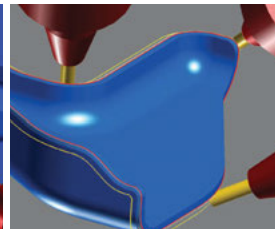

Chamfering – fixed tilt angle to surface

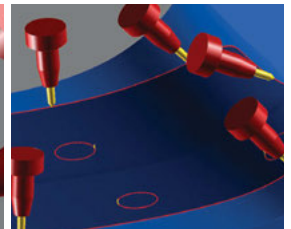

Engraving – perpendicular to surface

## 5axis top milling

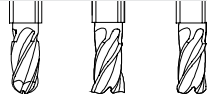

→ Machining of large, moderately curved surfaces

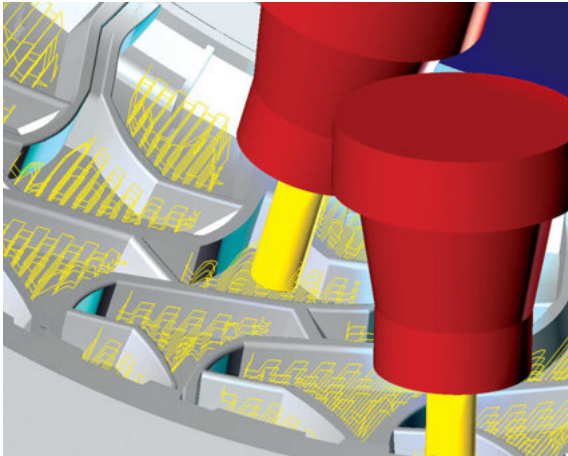

Roughing a shaped pocket base

Top milling reduces cutting time by allowing larger path step-overs. High-quality surfaces are achieved by automatically adapting the tool inclination for concave surfaces. Machining is not limited to single surfaces only. Furthermore, this strategy can also be used for very effective 5axis roughing, thanks to multiple infeeds and stock detection.

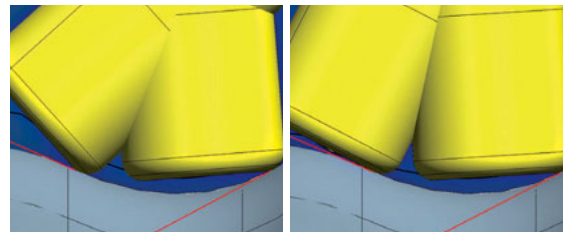

With constant optical path width

With optimal fit to the surface

## 5axis swarf cutting

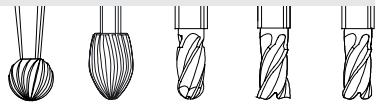

→ Machining of ruled surfaces

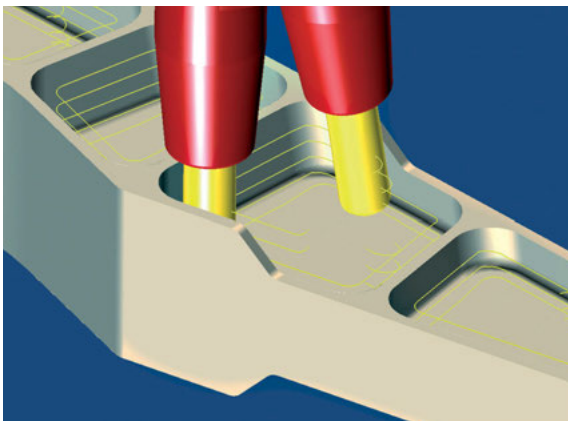

Machining ruled surface with flank contact

The side of the tool is used to machine workpiece surfaces with the swarf milling process. Large stopovers between paths reduce the cutting time and improve the workpiece surface finish. The tool is guided by a surface along a reference curve. As an alternative, it is also possible to guide the tool between two curves. Multiple axial and lateral infeeds make swarf cutting also suitable for roughing. Machining can be precisely and simply executed by defining stop and milling surfaces and stock tracking.

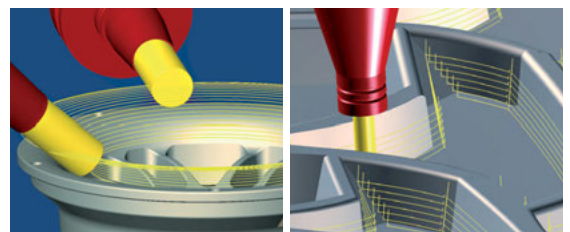

Machining double-curved surfaces with point contact

Swarf cutting with stop surface

## Specialised applications

Geometries such as impellers, blisks, turbine blades, tubes and tyres pose special requirements that standard strategies cannot satisfy. For this reason, *hyperMILL*® offers user-friendly special applications seamlessly integrated into the CAM system.



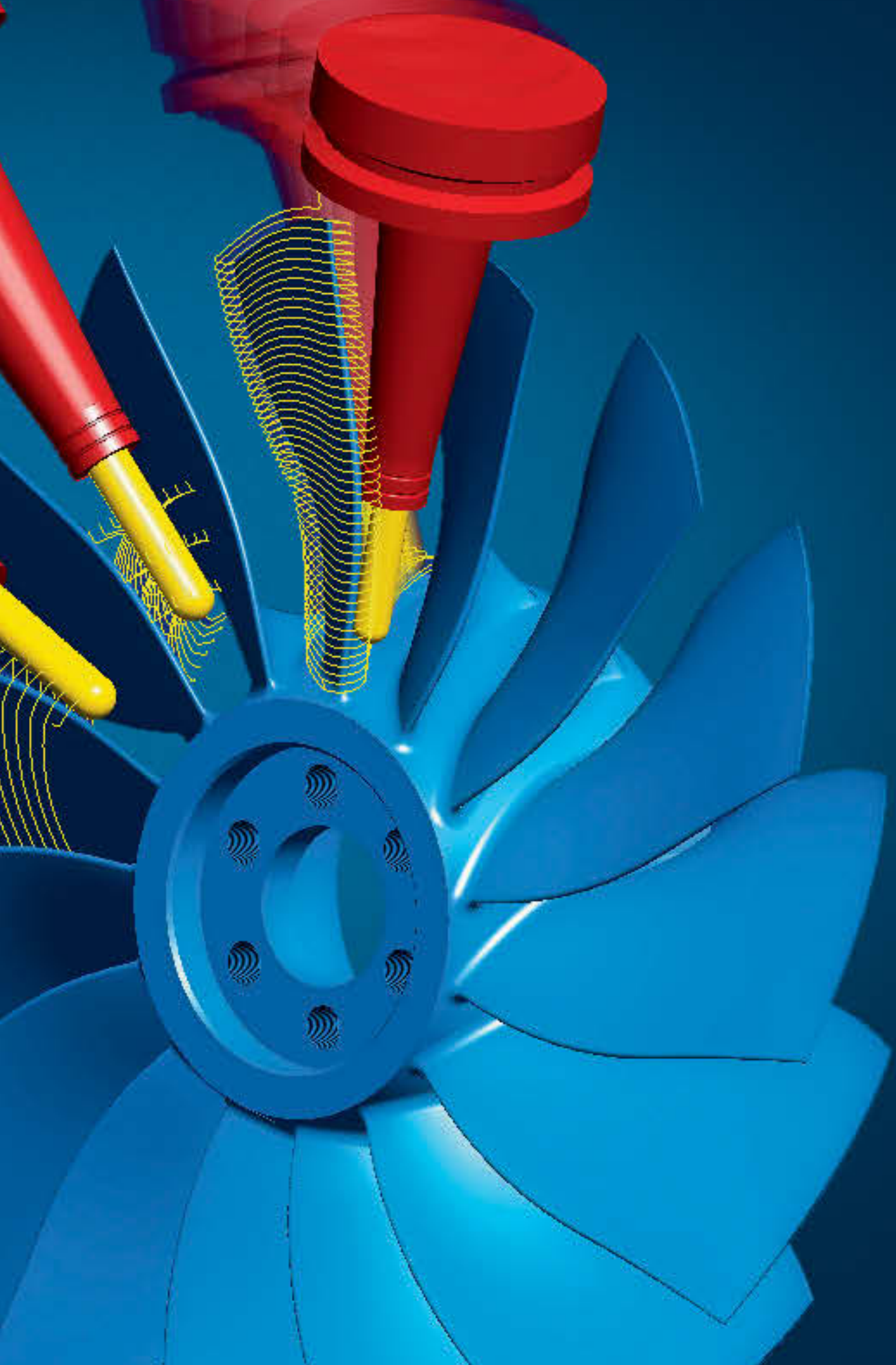

Specialised applications

## Blade package: 5axis top milling

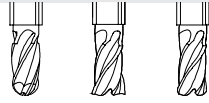

→ Finishing blade surfaces

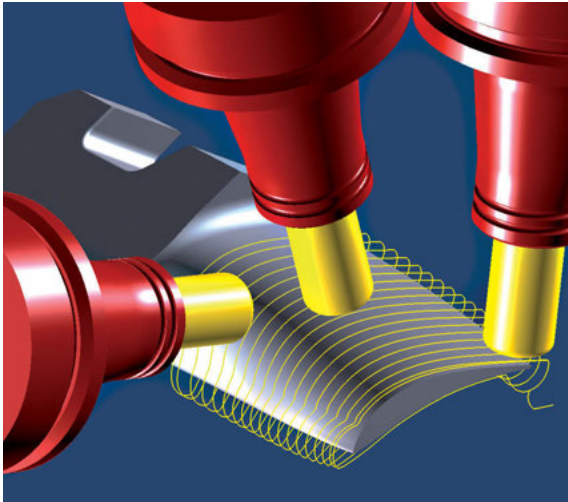

Continuous spiral path

5axis blade top milling enables continuously spiralling finish machining with freely definable offsets to the blade and side surfaces. The spiral tool path can be generated as a 5axis or 4axis simultaneous machining job. For endmills and bullnose endmills, the lead angle is automatically adjusted such that the surfaces are not damaged and the tool always cuts with the front edge.

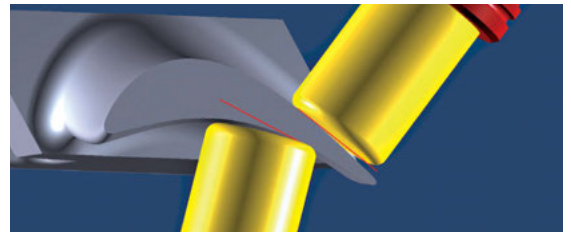

Automatic lead angle correction

## Blade package: Platform machining

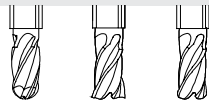

→ Platform machining, trimming and deburring of surfaces

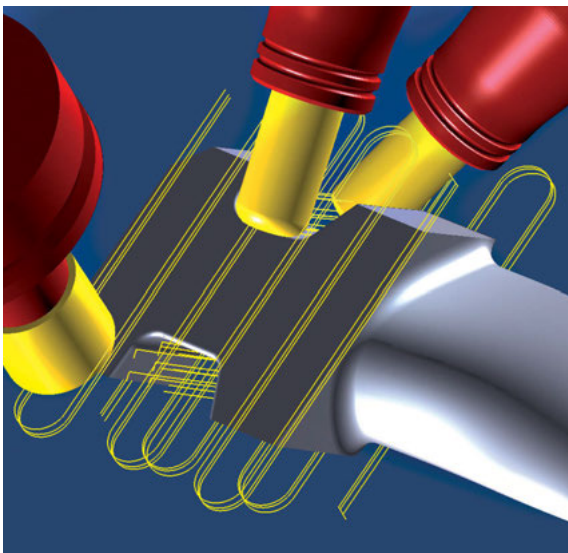

A number of 2D and 3D strategies are available for machining the platforms of a blade. The 2D category includes strategies for drilling, facing, curve and pocket milling. The various 3D operations include roughing cycles, finishing operations for the mechanical attachment geometry, as well as strategies for trimming, deburring or milling/machining curved surfaces.

Complementary strategies for platform machining



## Blade package: 5axis swarf cutting

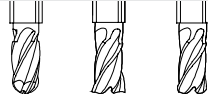

→ Rest machining, fillet milling, machining blade walls

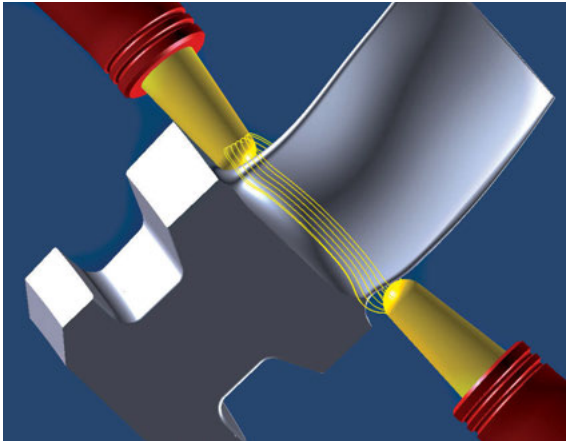

Blade swarf cutting

The tool moves in parallel or spiral paths around the blade to point-mill a seamless transition from top-milling of the blade surfaces to the platform surface including the fillets and to swarf-mill the platform surfaces.

A rolling ball fillet condition can be created even in conditions when the designed fillet would ordinarily can not be fully generated due to the platform dimensions. The tool maintains contact with the blade and a straight boundary of the platform to achieve a perfect transition in reference to the platforms of neighbouring blades, which cannot be achieved in many CAD systems.

## Blade package: Point machining



→ Machining blade and root surfaces

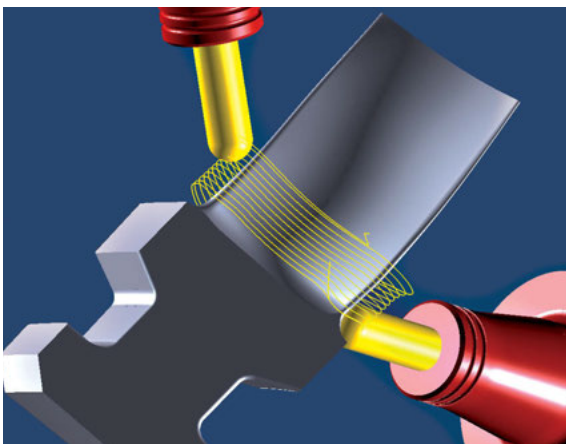

Point machining

5axis blade point milling optimises finishing at the transition between the blade and the root surface of the top or bottom. Overlapping toolpath for blade machining provide excellent surface qualities. Alternatively, a rolling ball radius can be generated here.

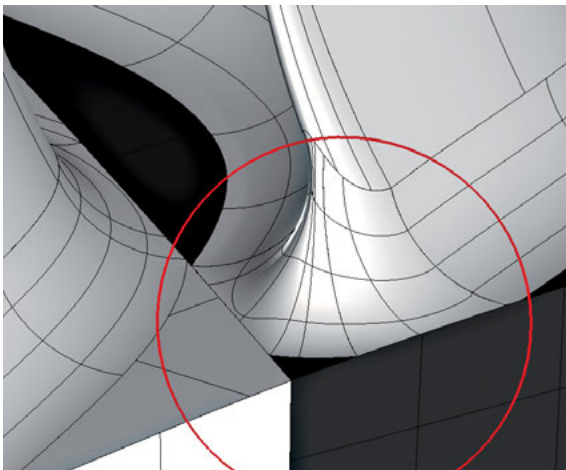

Surface transition with rolling ball function

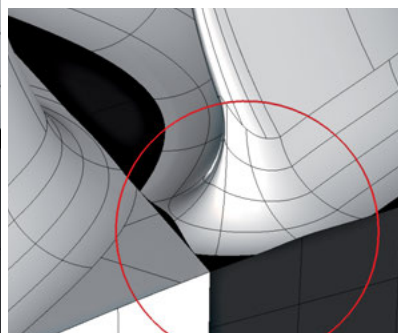

Transition without rolling ball function

## Multi-blade package: Roughing

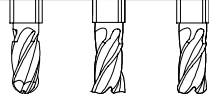

→ Pre-turned stock or semi-finished workpiece

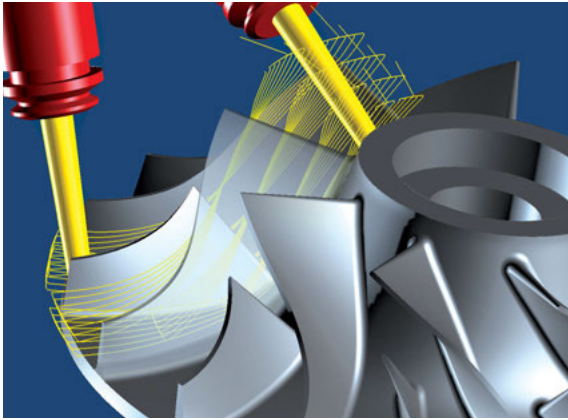

Continuous pocket-by-pocket machining

The most common roughing strategies are taking slices through the solid. Machining takes place pocket by pocket between the blades. Various roughing strategies such as “hub offset” or “shroud offset” enable control of path distribution, tool inclination and tool length to be optimally adapted to the geometry. Plunge roughing can also be used.

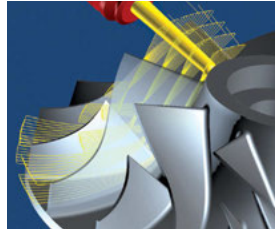

Layered machining parallel to hub

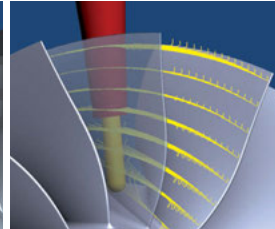

Layered machining perpendicular to hub

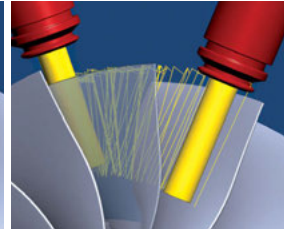

Plunge roughing with long narrow tools

## Multi-blade package: Hub finishing

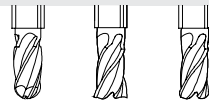

→ Hub finishing, rest machining close to the blade

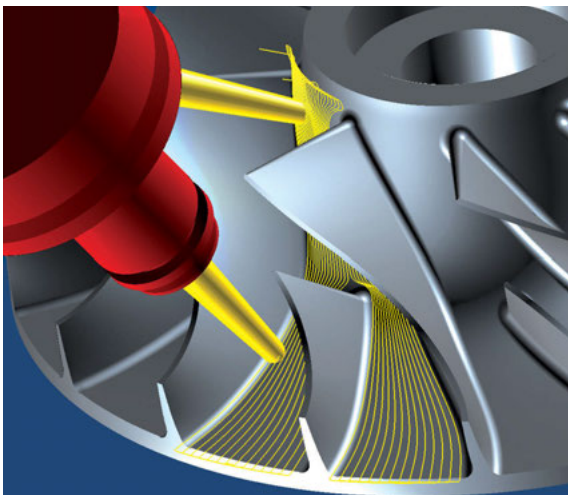

Complete or partial machining of hubs

This strategy is suitable for the complete or partial finishing of hub surfaces. With various infeed options and a scallop height function for the area around the leading and trailing edges, the machining job can be precisely adapted to the requirements and the machining time minimised. This strategy can also be applied as rest machining near blade surfaces.

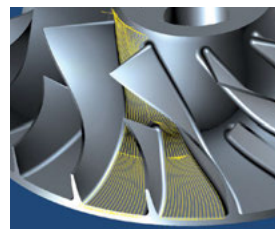

Shorter paths using special scallop height option

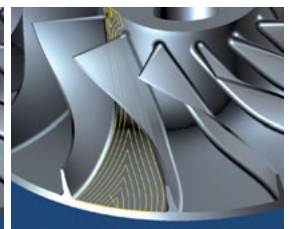

Shorter paths for the “pocket” infeed

## Multi-blade package: Blade machining

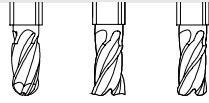

### → Milling blade surfaces

Depending on the blade geometry, blades are machined with point contact finishing or swarf cutting. Point milling is a very robust technology that is able to machine any blade geometry. It is used especially in high-speed applications, in the manufacturing of prototypes or when the blade geometry cannot be swarf cut with the necessary precision.

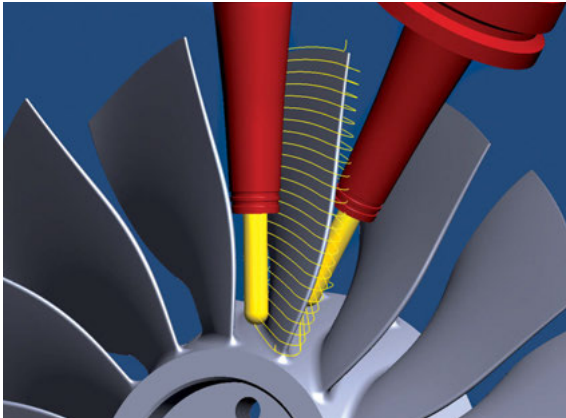

Point milling

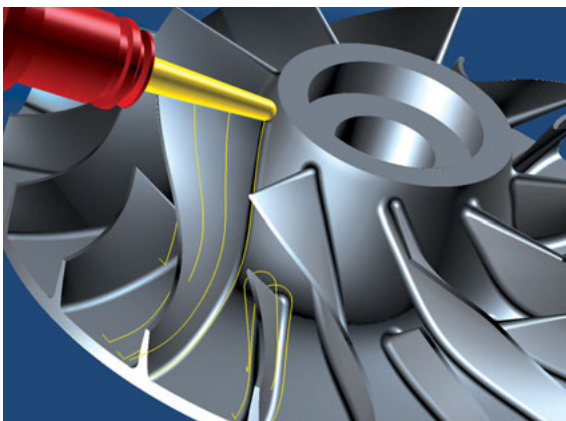

Swarf cutting

The flank contact with swarf cutting reduces the number of necessary machining paths and thereby the machining time required. The best fit of the tool to the surface is found simply by clicking the mouse. This option simultaneously indicates the surface quality that has been achieved.

## Complementary machining strategies



### → Milling the fillet radii between the blade and hub surfaces as well as between the leading and trailing edges

If the leading and/or trailing edges cannot be machined in a continuous operation around the blade due to the geometry or for technical reasons, multi-blade edge machining is applied. Milling transitional areas between the blade and the hub surfaces is used if the model contains very small or variable fillet radii.

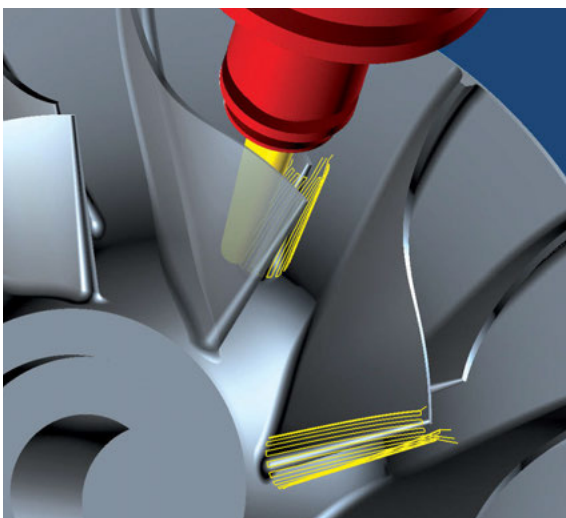

Machining leading and trailing edges



Milling transitional radii

## Tube package: Machining definition

→ With surface or digitised data

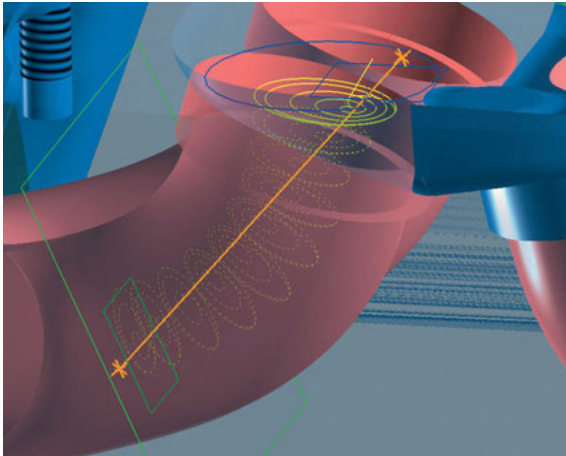

Simple definition of the central curve

All that is needed to define the particular machining type is a simple curve. There are no special requirements with respect to the surface definition, the number of surfaces, the quality of surface patches, the course of ISO curves or the surface orientation. It is possible to work directly with the digitised data.

## Tube package: 5axis roughing

→ 5axis roughing with undercut tubes from the full job

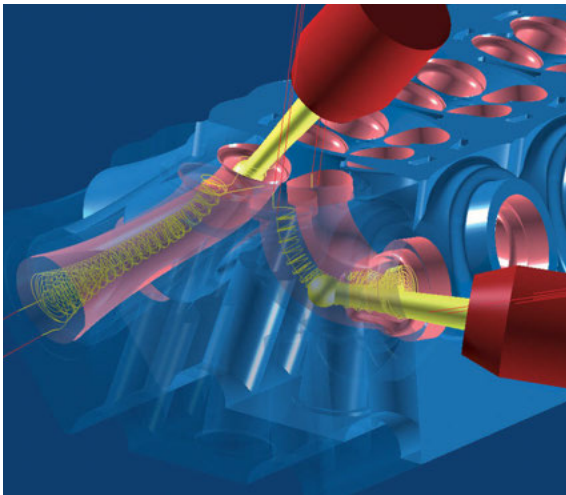
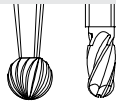

Effective undercut machining

This strategy is an effective alternative to machining with several jobs required for 3+2 machining. It enables the continuous roughing of a tube from the full job. There is spiral infeed to the bottom, and work is executed on the plane. Optimisation functions including preventing unnecessary movements of the rotary axes in strongly undercut tubes, allow processing of simple and complex tube geometries.

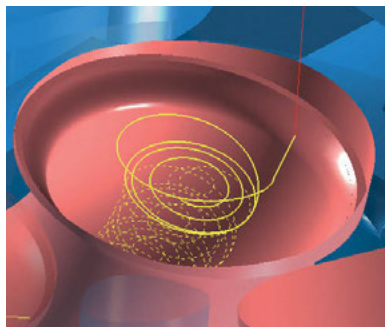

Removal from outside to inside

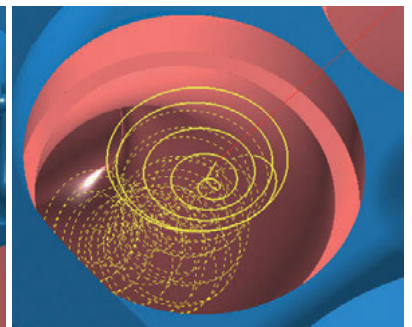

Removal from inside to outside

## Tube package: 5axis finishing

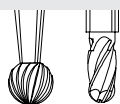

→ Fine machining of undercut tubes

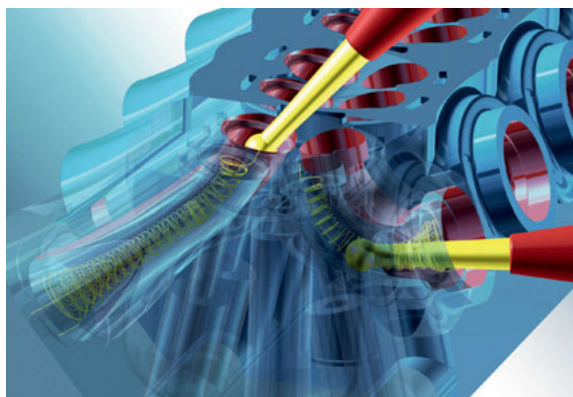

5axis Tube Finishing works with a spiral or parallel tool path. Spiral machining creates seamless surfaces. With parallel machining, it is also possible to avoid unnecessary movements of the rotary axes. Machining of inlet and exhaust regions can be easily matched to avoid overlapping paths. Collision avoidance allows tools with the shortest shank length, lollipops and tools with thick shanks to be used. Using the most stable tools guarantees high-quality surfaces.

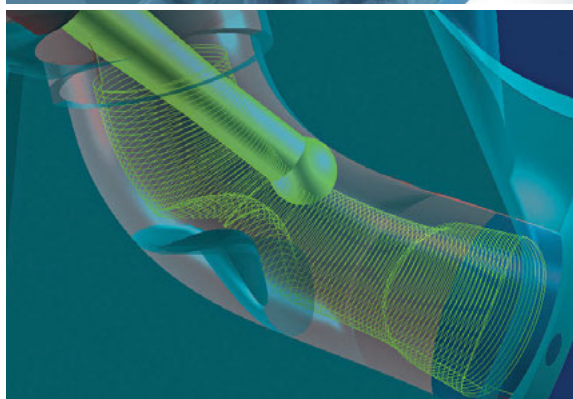

Seamless surfaces with spiral tool path  
Machining partially open tubes

## Tube package: 5axis rest machining

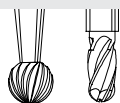

→ Machining of rest material areas

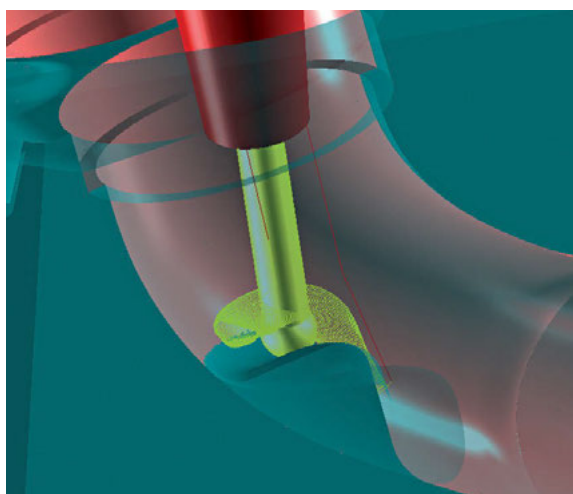

Rest machining in tubes

With this strategy, rest material areas are machined in either a spiral or parallel movement. The areas to be machined are described by a reference curve. The machining region can be limited by defining a value relative to the reference curve.

## Tyre package: Tyre clock

### → Description of the arrangement of identical tyre sections



Arrangement of identical tyre sections.

Tyre moulds consist of a complex pattern of repeating pitches that are machined into various mould segments. By recognizing the various patterns, *hyperMILL*<sup>®</sup> limits the programming to individual pitches. The tyre clock definition is used to define the pitch locations around the tyre mould, and specifically on each mould segment. The complete tyres are built up by means of the tyre clock in the most automated manner possible.

## Tyre package: Automatic segment generation

### → Automated programming

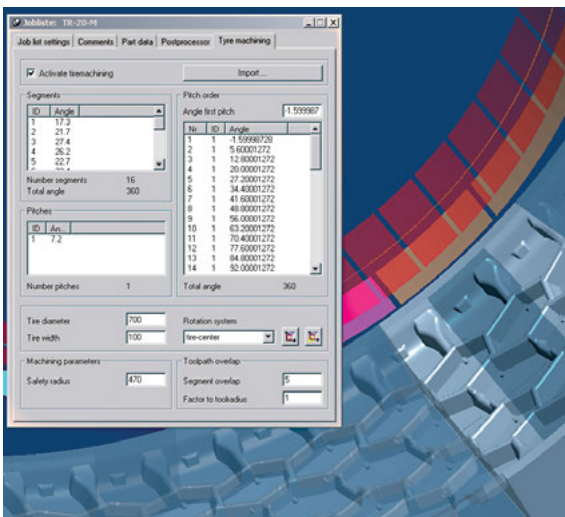

Copying tool paths to the corresponding position on the tyre form

When creating NC paths, the tool paths are copied to the corresponding position in the tyre. In doing so, the automated segment generation function adjusts the tool paths that go beyond the segment boundary.

## Tyre package: Machining strategies

### → Optimised milling strategies

With the tyre package, the dialogue boxes of all 2D, 3D and 5axis strategies are expanded by a parameter that allows the user to assign each machining strategy a pitch (section of identical construction). Most of the tyre machining process is based on foundation *hyperMILL*® strategies.

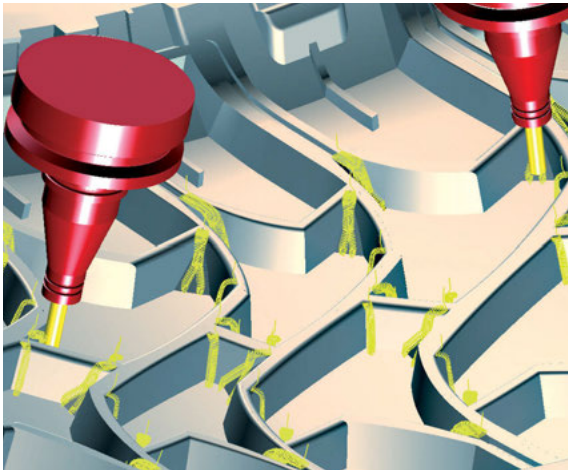
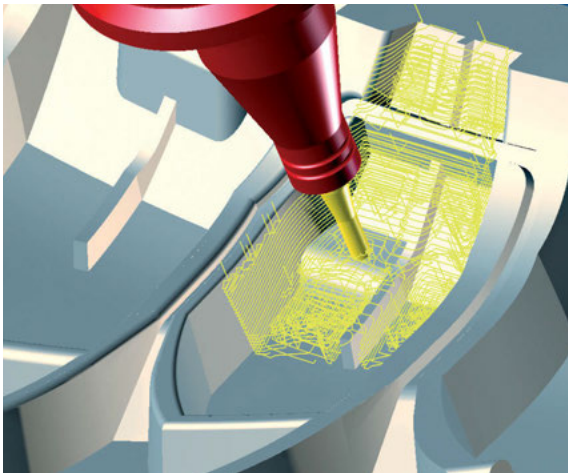
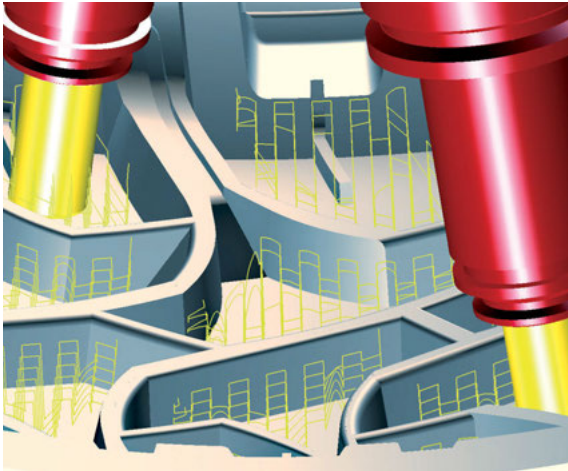

5axis roughing (top milling)  
3D roughing  
5axis rest machining

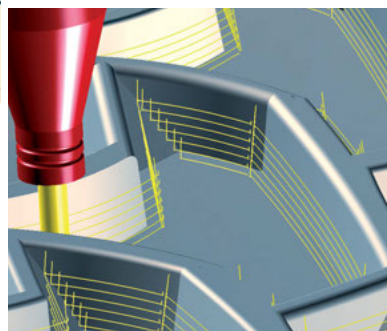

5axis swarf cutting

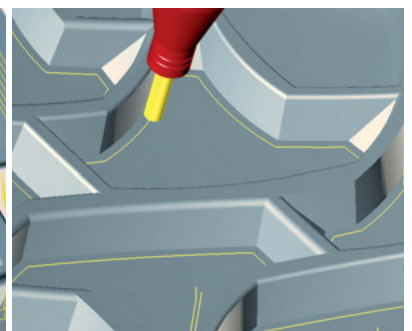

5axis contour machining



## Mill/turn strategies

The *millTURN* module of *hyperMILL*<sup>®</sup> enables the creation of NC programs for turning and milling in a single set-up. Because of the module's complete integration, the tool database, stock tracking and collision check functions as well as post-processors can be used together for all milling and turning operations.



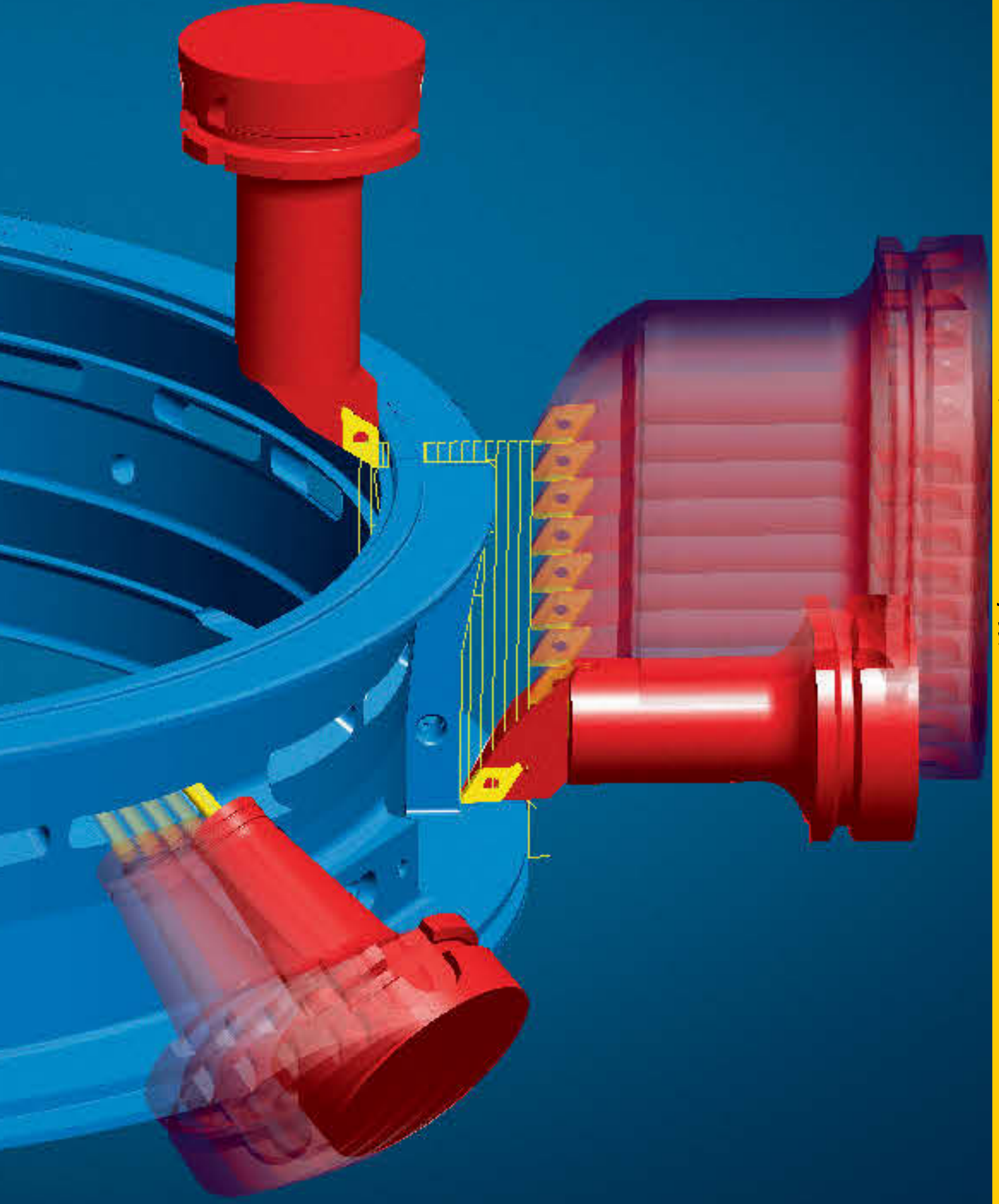

Mill/turn strategies

## Turning contour and turning stock definition

### → Simple and convenient creation of turning contour and turning stock

With *hyperMILL*<sup>®</sup>, the user can automatically generate the turning contour and turning stock for machining. The turning contour can be created by selecting a 2D contour and a corresponding axis, or can be automatically generated via surface/solid/STL selection (maximum interference contour) by entering the frame and tolerance. The software automatically takes into account elements that are to be milled in subsequent steps. This results in a turning contour that ensures precise machining for rotationally symmetrical elements.

In addition to the turning contour, the turning stock can also be automatically created. With stock tracking and the option of switching between milling and turning stock, you can always work with the current stock. This ensures precise machining and helps to avoid unnecessary redundant movements. The following options are available for the definition of turning stock:

- Generate on the basis of 3D milling stock
- Define by surface/solid/STL selection (maximum interference contour), specification of axes and tolerance
- Define as cylinder with or without stock allowance
- Define as pipe with or without stock allowance

To define the bounding geometry, the surfaces are selected by clicking on them with the mouse. *hyperMILL*<sup>®</sup> automatically creates the corresponding geometry. In addition, a parallel stock allowance can be defined as an offset to the contour, for example for cast parts.



Defining the bounding geometry

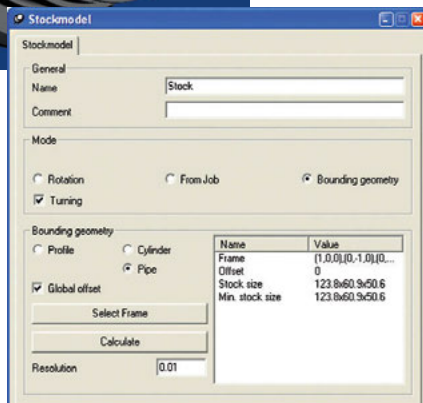

## Drilling

### → Drilling with a fixed tool

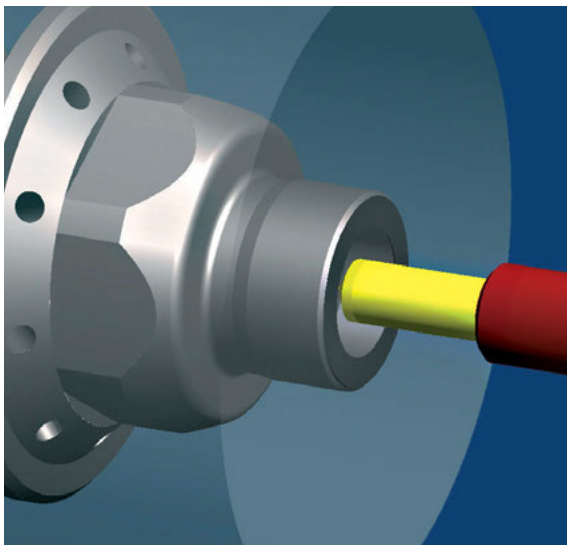
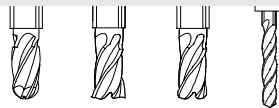

This strategy is suitable for creating holes in the centre – on the turning axis of the part – including stock tracking with a fixed tool. On mill/turn machines, this strategy offers an alternative to helical drilling.

Fixed drill and rotating workpiece

## Turn roughing

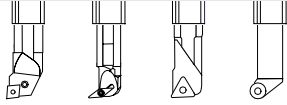

→ Machining of rotationally symmetrical interior and exterior stock surfaces of any shape

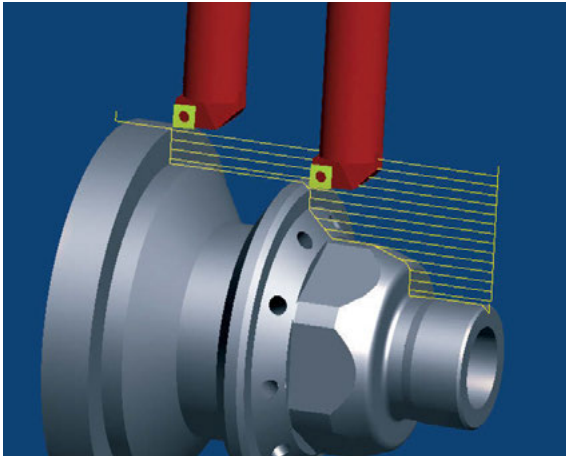

Axis parallel roughing

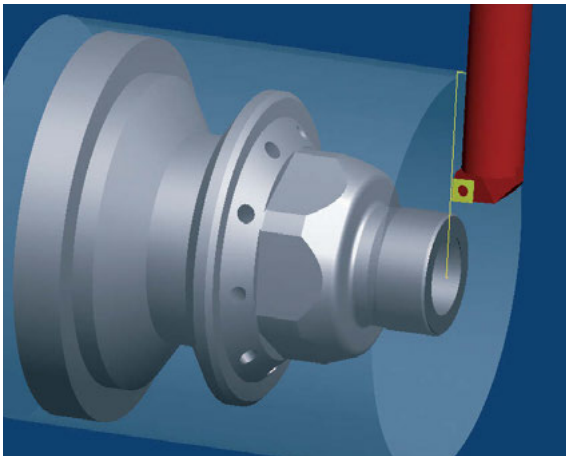

Face turning

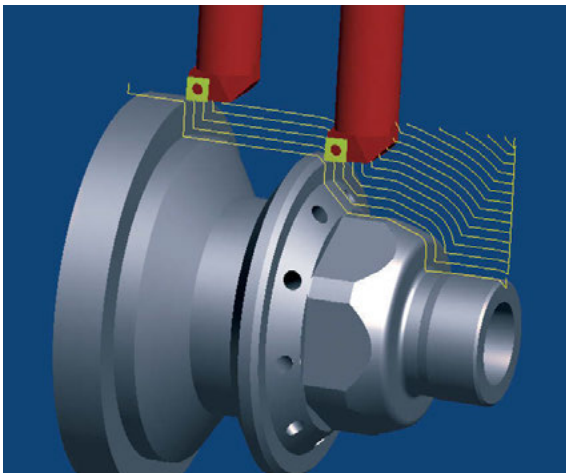

Contour-parallel roughing

Machining with turn roughing occurs in an axial, radial or contour-parallel direction, including determination of the cutting edge angle for downward cuts. Functions such as the definition of workpiece positions, contour selection, stock trimming, stock tracking or path compensation enable an optimisation of the machining job. Tool definitions may also be made using standardized ISO definitions.

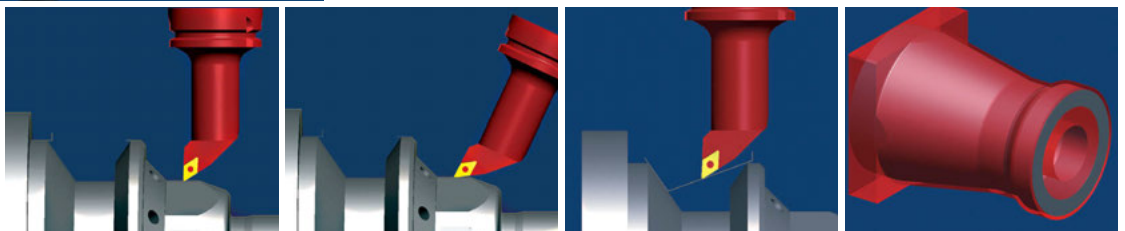

Positioned turning with optimised tool inclination

Clearance angle to protect the insert

Stock resulting from turning and milling processes

## Turn finishing

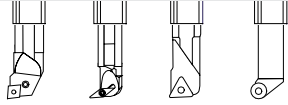

### → Contour-parallel finish machining of rotationally symmetrical surfaces

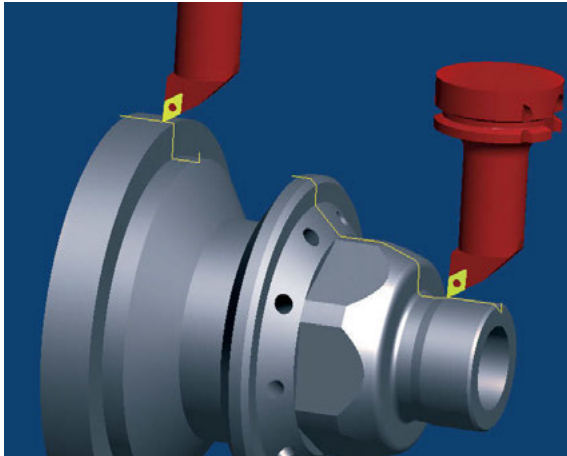

Turn finishing

With this strategy, the roughed surfaces of workpieces of any shape are finished in a contour-parallel manner, recognising the cutting edge angle for downward cuts as well. Functions for defining tool inclination, approach and retract macros, path compensation and stock offer various options to meet the needs of any machining job. The various approach and retract macros can be combined with each other.

Slope-dependent finishing specifically enables the machining of flat and steep regions and ensures optimal cutting conditions during finishing. To define the areas to be machined, the user first selects the entire contour. Next, the user defines the areas that are to be machined and the maximum slope angle to be used in the single-step process.

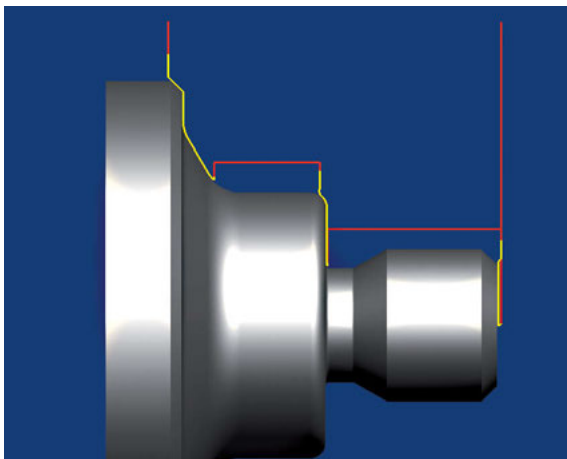

Steep regions

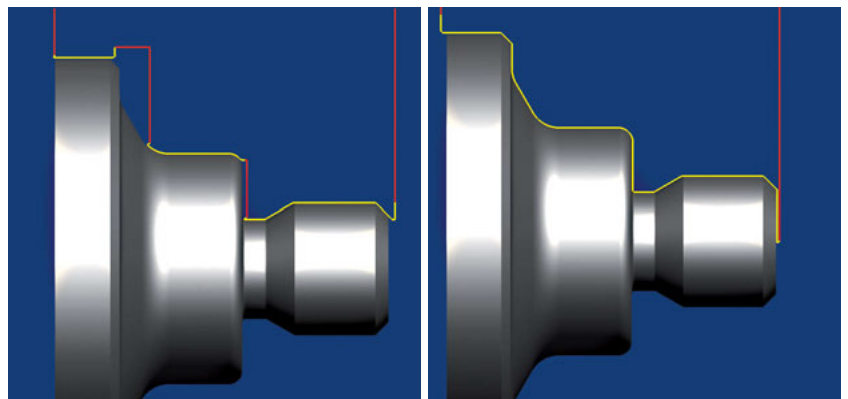

Flat regions

Slope-dependent turning deactivated

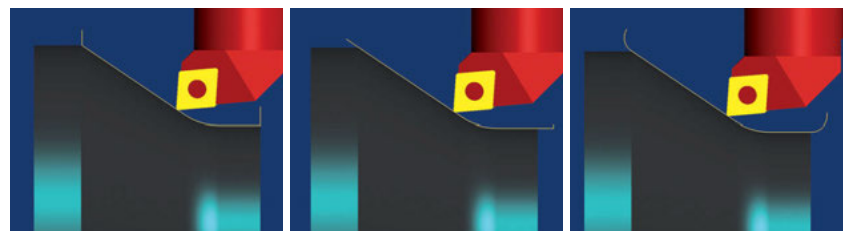

Approach and retract macros

Tangential approach and retract macros

Approach and retract in an arc

## Grooving

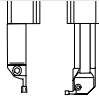

→ Workpieces with grooves or shoulders

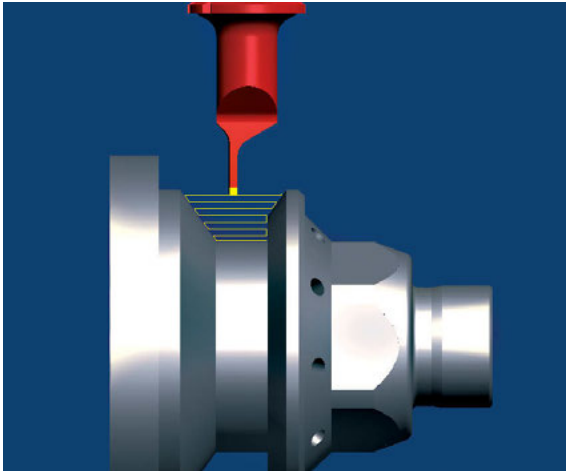

Axial grooving

The operations of grooving, parting off and groove turning are programmable with this strategy. Workpieces with grooves and shoulders can be machined either radially or axially. To optimise the machining process, the ISCAR groove strategy is implemented. This automatically accounts for the lateral displacement of the cutting length as a result of the lateral cutting forces. Further optimisation functions are available, such as finish pass, wall distance, ramp angle, tool path compensation or chip break. This strategy also enables slope-dependent machining.

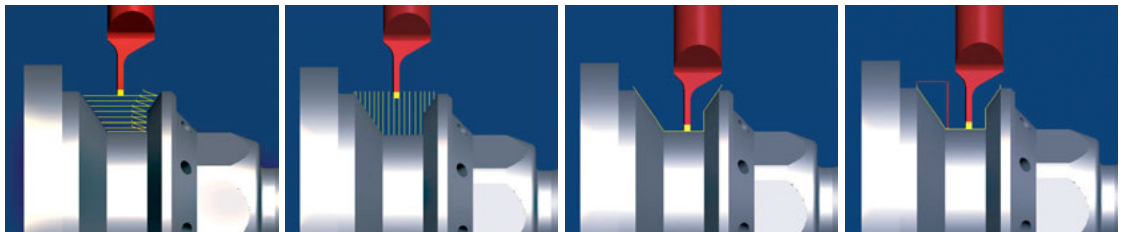

Axial grooving with ramp for materials difficult to machine

Radial roughing for narrow and deep grooves

Rework machining in one step

Rework machining only from top to bottom

## Thread cutting



→ Creation of external and internal threads with constant pitch

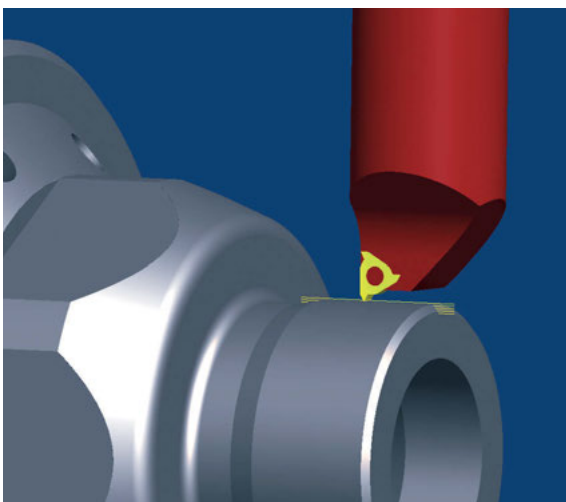

Turning an external thread

Thread cutting enables the turning of single or multiple, cylindrical and conical shaped, external and internal threads. Infeed occurs with either constant chip section or constant X-value. Threads are very easy to define by determining the outer edge of the thread, core or outer diameter, as well as leading or trailing movement. Control of the infeed, the infeed angle or the finishing allowance make it possible to respond to individual requirements.

# General functions

Functions that apply to all strategies, such as stock tracking, milling and stop surface concepts or automatic collision avoidance, provide for effective, user-friendly techniques.

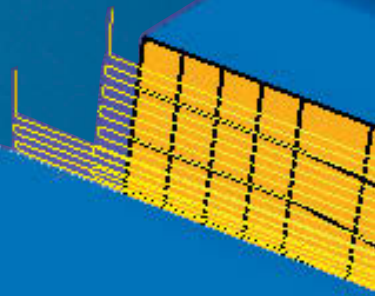

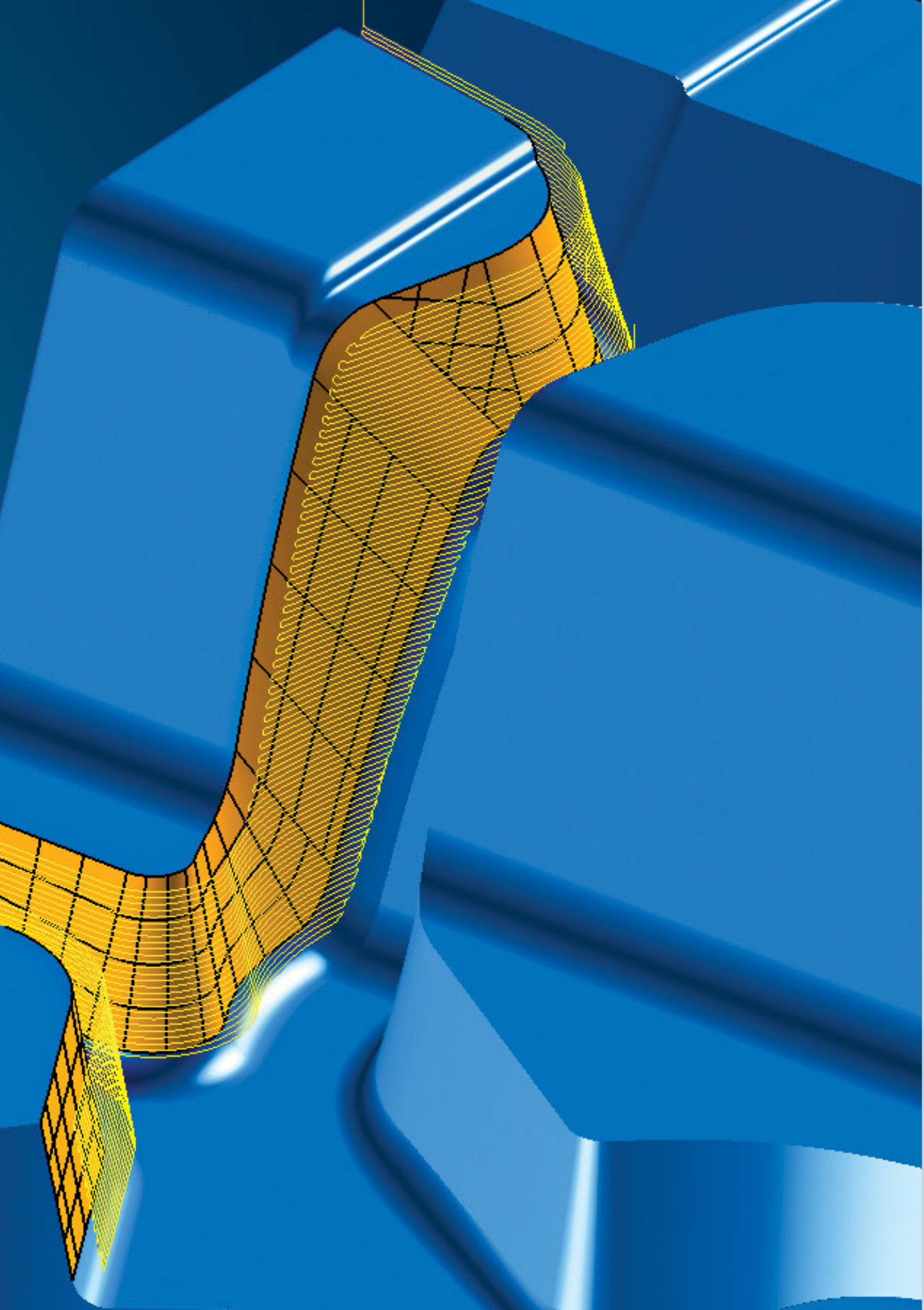

## Analysis functions

### → Verification of parts and tools for efficient job planning and CAM programming

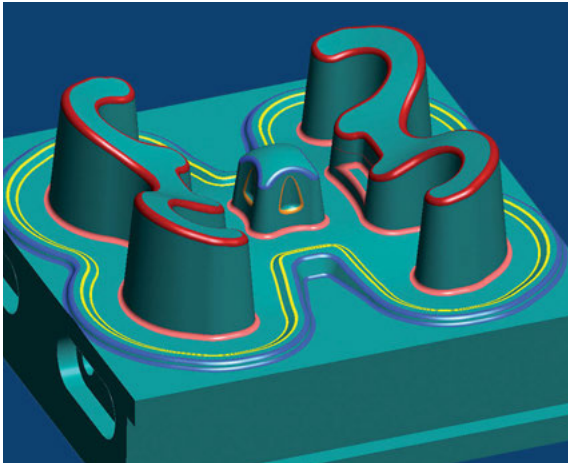

Model analysis

The functions for modelling, surface and tool analysis allow users to quickly and easily determine which element properties in a component are relevant for machining tasks. By simply clicking on a surface, users receive important information on the surface type (radius, plane, free-form surface), minimum and maximum radius, position and angle as well as picking point coordinates for the selected frame system. When two elements are selected, the function displays the minimum distance and angle between the two surfaces.

In addition to analysing individual surfaces, *hyperMILL*® can automatically search for all planes and radii on a component and also mark their positions and sizes accordingly.

Various machining data, such as machining type or tolerances, are often compiled into standardised colour tables. These can be stored in *hyperMILL*® so that users have easy access to tolerance and fit data for holes or other geometries to be machined in a component.

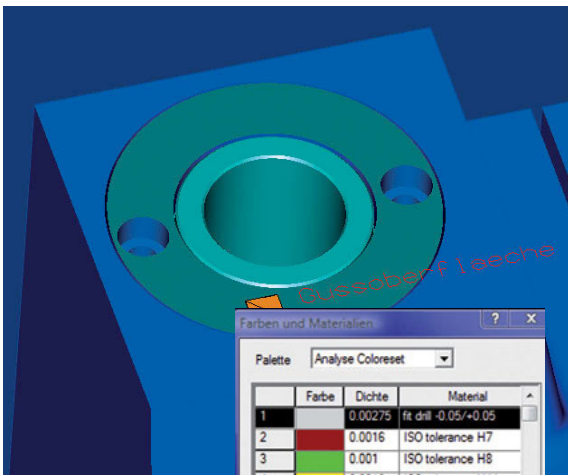

Integration of standardised colour tables

Palette	Analyse Coloreset	Farbe	Dichte	Material
1			0.00275	fit drill -0.05/+0.05
2			0.0016	ISO tolerance H7
3			0.001	ISO tolerance H8
4			0.0016	ISO tolerance H11
5			0.0014	tapped hole - metric

Manual positioning of any tool allows users to quickly and easily check whether areas that are difficult to access can be machined and, if so, at which angle. To do this, any tool defined in *hyperMILL*® can be moved to any position and freely rotated around all axes. Thanks to the tool length optimisation analysis function, a CAD model can be checked for collisions as long as collision checking is activated and the milling area is defined. Furthermore, the user has the option of importing the tool and frame to be analysed directly from an existing job, or exporting a frame to the *hyperMILL*® frame list.

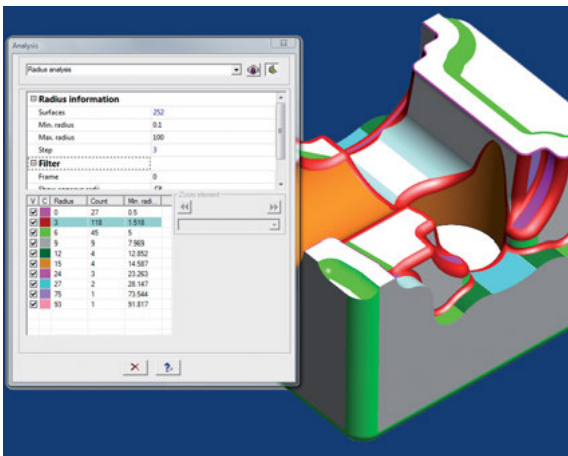

Analysis of existing radii on component

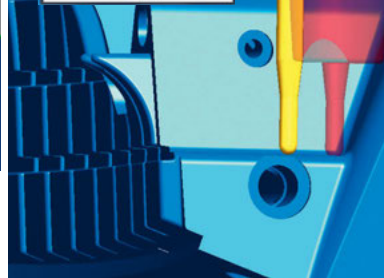
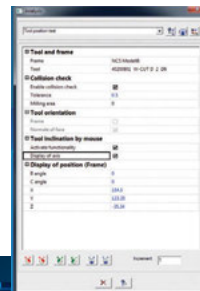

Tool length optimisation

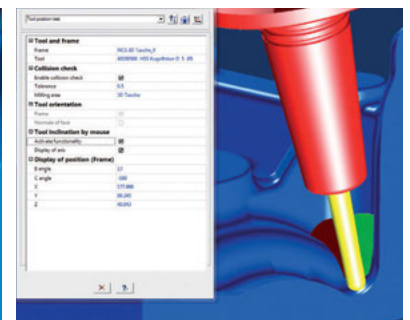

Tool positioning and collision checking



## Stock tracking and management

### → Simple, transparent monitoring of the machining status

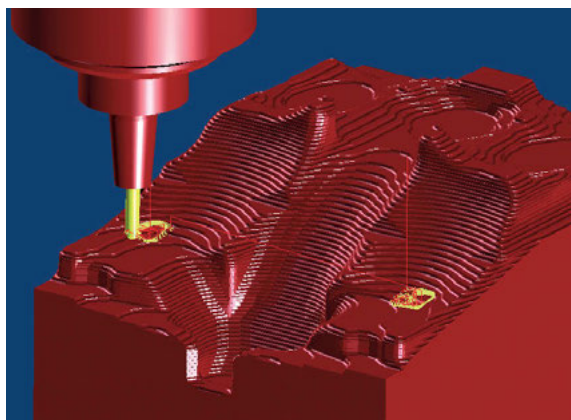

Stock tracking allows calculating the machining status for each single job, for any number of freely selected jobs or for the entire job list. Stock models are maintained, independent of the reference frame for a machining job and can be used to limit the machining area. Job list-oriented stock tracking and management guarantee extremely precise and efficient material removal. Stock is automatically updated via all turning and milling operations.

The compound stock function allows for machining multiple components, each of which have their own stock, at the same time. The different stocks are combined together, allowing a component (and stock) to be machined free of collision in relation to the completely assembled stock.

Calculated stock is shown in a separate window and managed in the job list. Stock can be used for visual checks as well as for any further machining, such as the roughing of arbitrary stock. Stock can be saved in a CAD-neutral STL format.

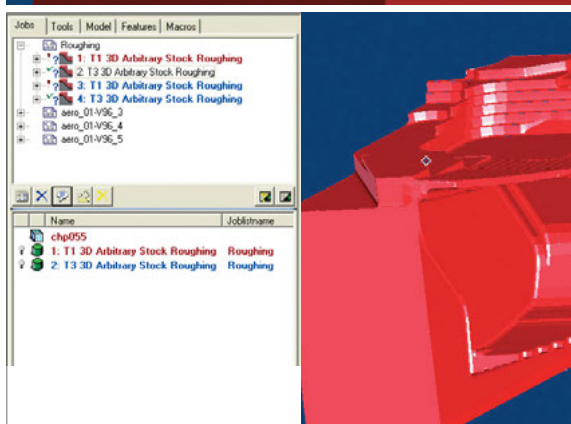

Stock calculation following each machining job  
Job list with stock management

## Milling/stop surfaces

### → More exact machining, flexible and accurate limiting of machining areas, increased precision

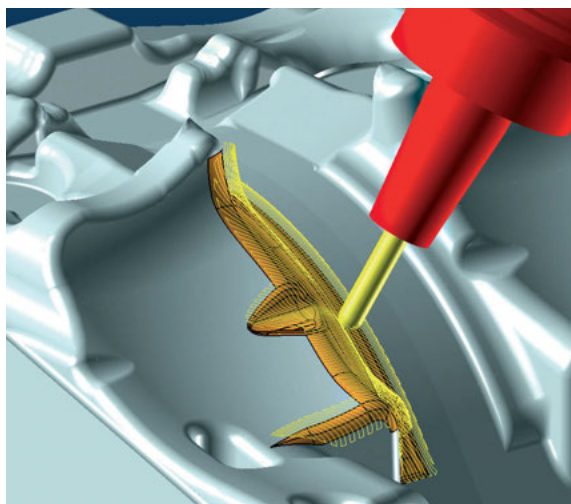

Precise area definition using stop surfaces

In addition to employing the conventional boundary method to define the machining area, milling and stop surfaces can be used as well. By selecting the milling surfaces, the user directly defines the areas to be machined with a few clicks of the mouse. You can also specify the milling area using bounding curves and stop surfaces. During the machining process, tools will not come into contact with stop surfaces.

## Transformations

### → For reproducing machining jobs on identical or similar geometries

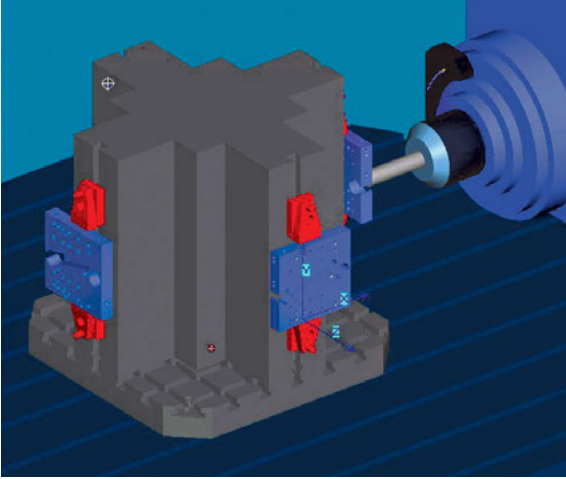

Using transformations, it is possible to reproduce programs for machining identical or similar geometries within a component or several identical components that are clamped together. By freely transforming machining steps across spatial coordinates, users can simplify their programming workload and reduce costs. In other words, multiple copies of machining steps can be placed along the X and Y axes or rotated around a freely definable axis.

With transformations, users can easily and conveniently create programs for multiple components clamped within a single plane or in a tombstone fixture, for example. Since the “copies” are associated with the job template, modifications to a program or geometry can be implemented quickly and easily. Any changes to the job template are copied automatically by *hyperMILL*® to the associated jobs. Furthermore, each parameter can be modified individually. Since users can make local changes or even delete parameters and dependencies, workflows remain highly flexible (see also “Associative programming” on page 6).

Another powerful feature is that users can perform collision checks relative to the finished part for programs that have been offset or rotated. This means that jobs involving tombstones or multiple setups can be programmed efficiently and reliably.

Transformations can be applied to all job steps.

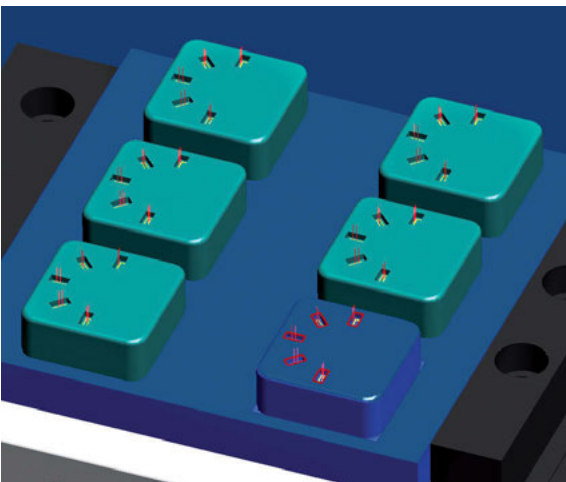

Spatial copies of programs

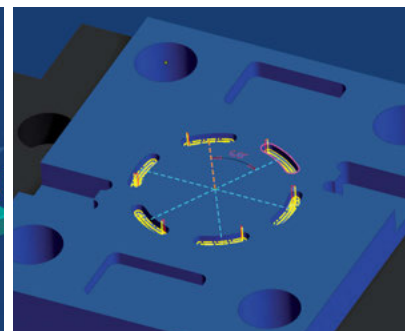
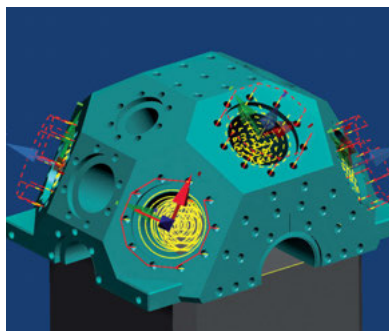

Copies of program sections for components with identical elements

## Mirroring

- **Creates symmetrical geometries or geometrical planes in components and determines entire machining programs for mirrored components**

In contrast to simple mirroring actions performed by machine controllers, *hyperMILL*<sup>®</sup> does not merely mirror the NC paths. An independent toolpath is calculated for the mirrored geometry including modified technology values. Climb milling movements remain intact. Automatic approach and retract strategies, curve orientations and optimised infeed movements are taken into consideration in mirrored jobs.

Mirroring automatically creates an associated element in a browser. Any changes to the original are automatically applied to the mirrored versions. Again, every parameter can also be modified individually if required. Mirroring can be applied to all job steps as well as to the entire job list.

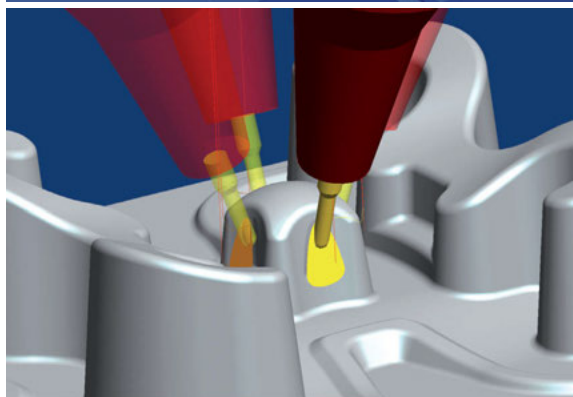
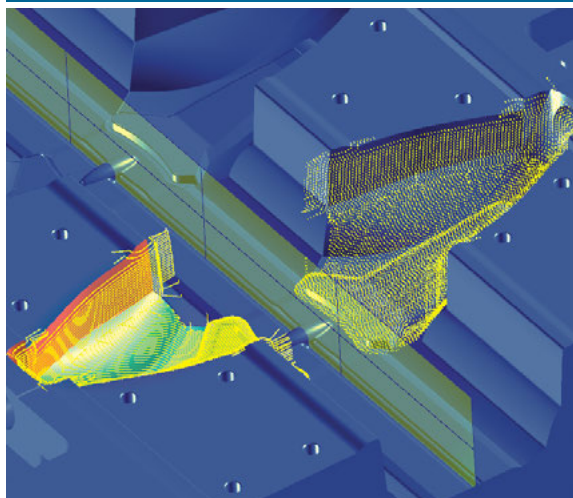
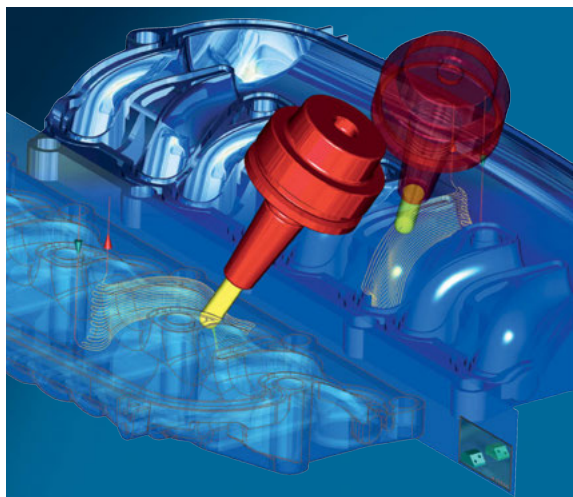

Geometry and boundaries are mirrored

## Job linking

### → For intelligent links between jobs and effective reduction of transition moves

Multiple job steps to be machined with the same tool can be combined into a single step using job linking. Here, each of the job steps remains unchanged. *hyperMILL*® calculates the NC toolpaths between these steps with respect to the workpiece and performs a collision check. Each job link is established independently of the type of machining (2D, 3D and 5AXIS machining) and machining direction. Even undercut areas can be approached safely with job linking.

This unique function allows users to combine multiple strategies into a single processing cycle. This gets rid of retraction movements between the individual operations and significantly reduces machining times

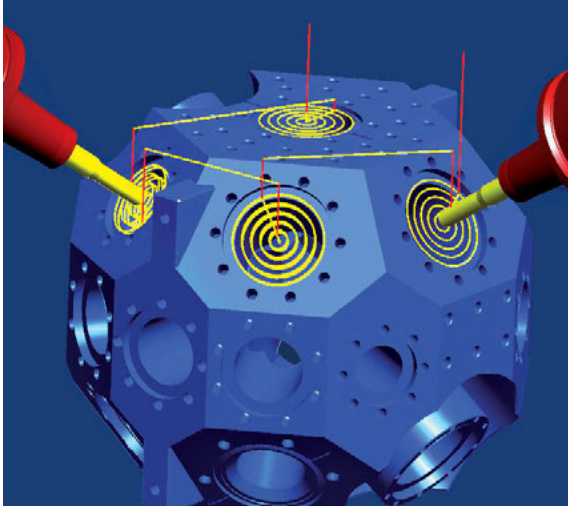

Collision-checked link

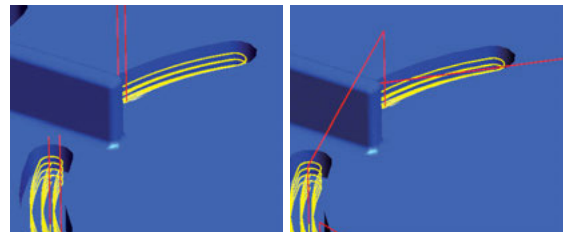

With and without job linking

## Production mode

### → Automatic optimisation of transition moves for shortest possible machining times of standard parts

Production mode is a new function that lets you minimise all transition moves within a job. *hyperMILL*® automatically optimises fast travel movements according to the path length by stepping over or sideways around the geometry to the starting point of the next path. Lateral movements help to avoid unnecessary infeed movements at the Z-level that are mostly performed with reduced feedrates. By including the stock in the collision calculation, *hyperMILL*® ensures that transition moves remain reliable.

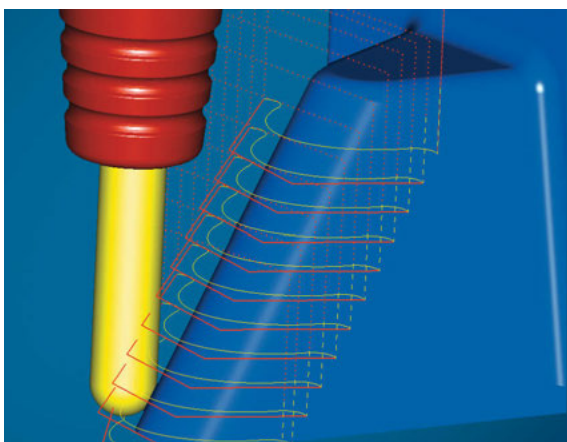

Machining with production mode

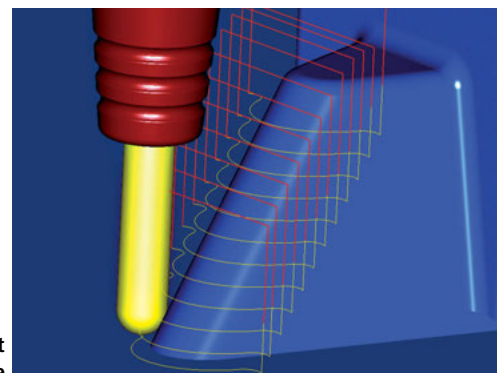

Machining without production mode

## Collision check with safety allowance

→ Better process reliability, high level of flexibility

*hyperMILL*® detects collisions and offers efficient solutions for collision avoidance. NC tools can be described in a very detailed manner, including holder, tool shank, any number of extensions and a spindle protection area. Different geometries can be used for calculation and simulation. Depending on the tool and machining strategy, there are different options available for collision control and prevention. To be on the safe side, tool components that are not selected for collision checking are highlighted.

When performing a collision check against the model, different safety allowances can be defined for all tool components (spindle areas, holders, extensions and shanks). This makes the evaluation of different pre-machining conditions very easy. The geometry of the tool elements does not have to be changed for collision safety.



Definition with safety allowance

## Tool length calculation

→ Extended tool definition and collision checks

This function, based on the default tool length, calculates both the necessary maximum and minimum tool reach required to avoid collisions whilst maintaining rigidity in the tool. The extend function calculates the larger reach. The shorten optimisation function calculates the clamping length of the selected tool in such a way that it is not longer than absolutely necessary and does not fall below the minimal length. If a longer tool is required, the area is left out or the calculation is cancelled.

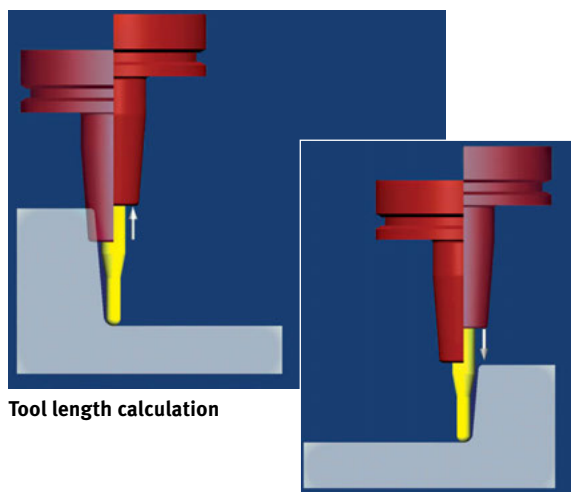

Tool length calculation

## Fully automated collision avoidance

→ **Skipping toolpath areas, changing tool orientation during active collision avoidance**

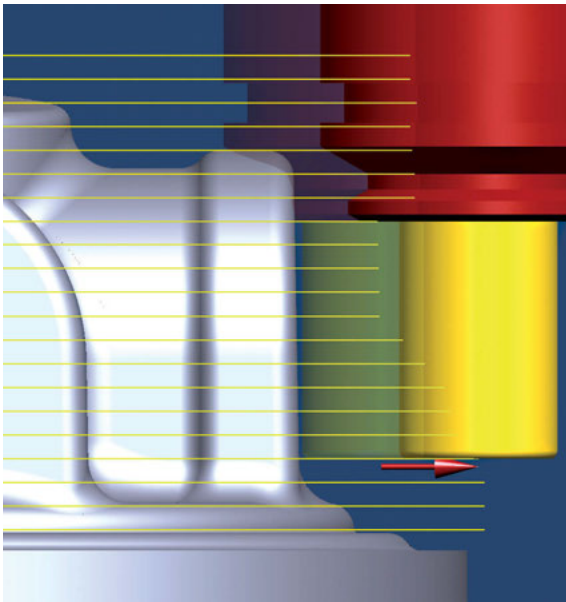

Checking and avoiding collisions

Fully automatic collision avoidance is an active type of collision avoidance that independently attempts to determine a collision-free tool angle. During roughing, for example, the paths can be moved laterally, thereby allowing greater machining depths. During finishing with 5axis simultaneous machining, *hyperMILL*® uses fully automated modifications of the tool orientation to prevent collisions. Tool orientation modification can be performed either in 5axis simultaneous machining or via automatic indexing. Moreover, it is possible to cancel machining or skip toolpaths with collisions in order to mill them with longer tool lengths and/or modified tool angles.

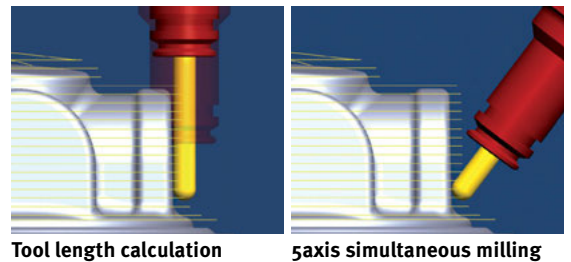

Tool length calculation

5axis simultaneous milling

## Selectable axes for avoiding collisions

→ **Taking account of machine kinematics**

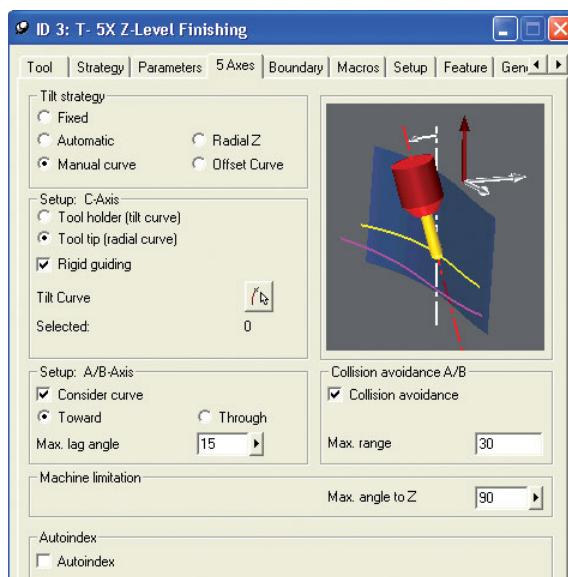

The programmer can specify, in reference to the component and the machine kinematics, which of the two rotary axes is preferred for collision avoidance. Several options are provided:

- Only the C-axis is used – the fifth (A/B) axis is on a fixed inclination
- The C axis is used in preference to the A/B axis
- Only the A/B axis is used – the tool on the C axis strictly follows the guide data
- The A/B axis is used in preference to the C axis

In addition to simpler programming and taking account of machine kinematics, minimised axis movements provide for more consistent tool movements.

Selectable axis for smoother machine movements

## Tool database

### → Extensive definitions of tools using technology data

hyperMILL® comes equipped with a fully redesigned tool database. Tools can now be defined with greater versatility and much more realistically. Complete tools can be imported, individual tools can be defined and complete tools including holders can be custom-assembled. To fully assemble a tool, freely definable tool extensions are available with corresponding coupling systems.

By entering the technology data for tool extensions, copying tools into a job list automatically changes the corresponding technology values.

In addition to the material-specific cutting data, users can also create various profiles for each tool defined in the database. Thus, different applications can be predefined and selected in the job steps – even for the same workpiece and cutting materials.

A neutral data exchange format is available for importing and exporting tool data. Input synchronisation enables automatic data reconciliation with other database systems.

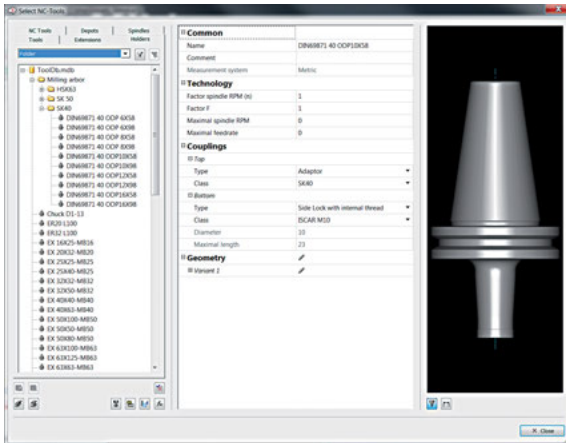

Freely definable tool holders

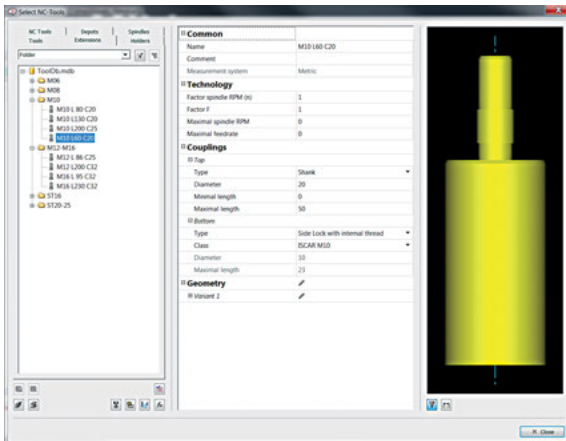

Freely definable tool extensions ...

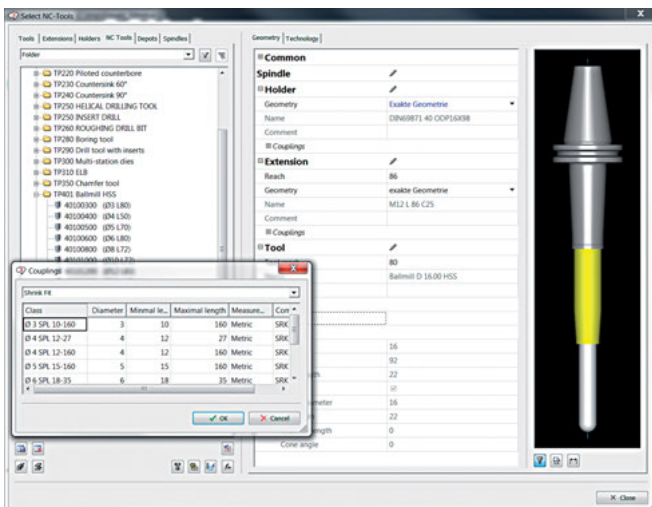

... Corresponding coupling systems



## Feature and macro technologies

With feature and macro technologies, *hyperMILL*® users can standardise and automate the programming of geometries. It offers many options for using CAD geometry information for CAM programming and to define typical and repeating geometries as a feature. A new feature type, the customised process feature, is used to define job templates and operating standards.



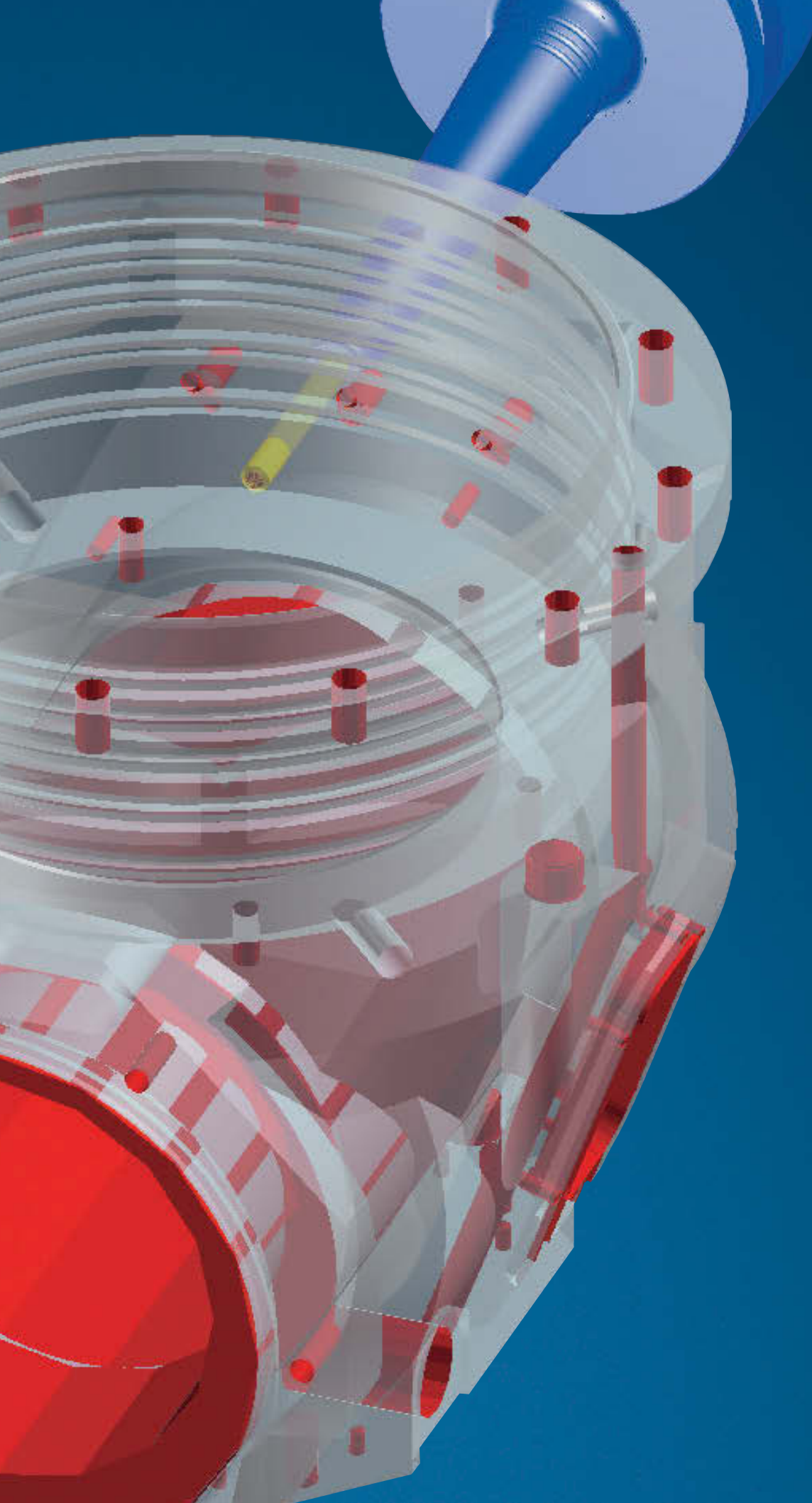

## Automatic feature recognition

→ Detection of geometries, creation of boundaries, leading curves and profiles, as well as grouping of surfaces and holes

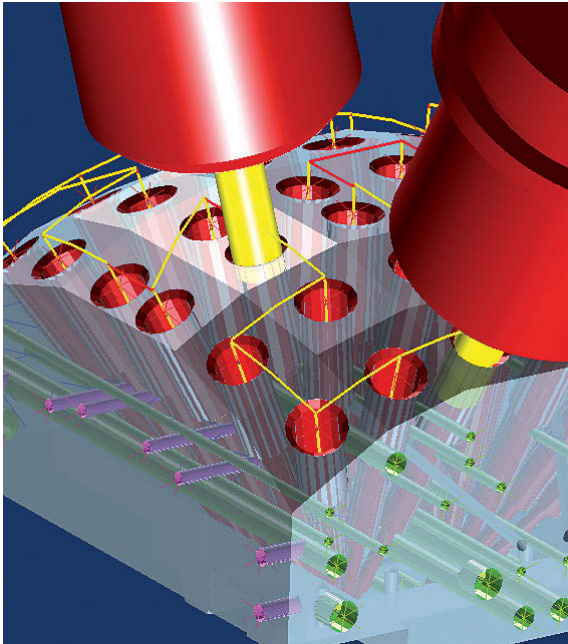

Applicable in 2D, 3D and 5axis operations

Automatic feature recognition detects geometries from solids and surface models, such as holes, stepped holes with and without threads and open and closed pockets. Parameters are automatically generated that are required for the programming of machining strategies and for tool selection.

Features can be automatically or manually grouped, for example based on type, diameter or workplane. Various filters support the grouping function. Because features are summarised in different ways within a group, programs for multi-axis indexing can be generated without additional programming work.

## Feature mapping

→ Importing of features from solids

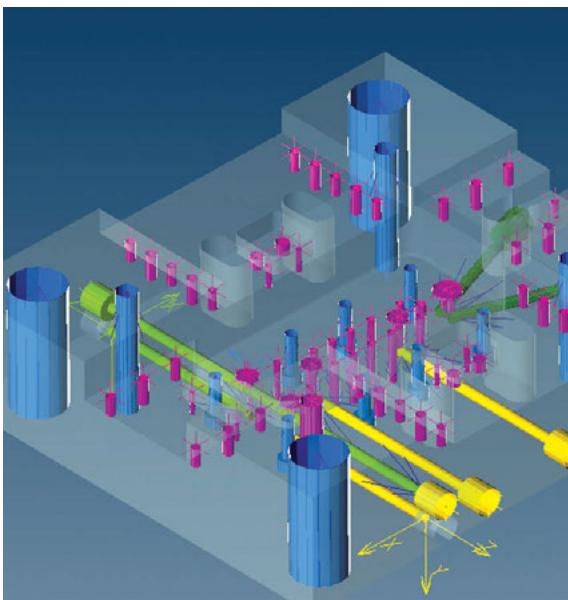

Feature mapping on solids

The feature mapping function is used to search for drilling geometries such as holes and threads from the feature-tree of a solid with all the detailed parameters in one step. Application of colours and viewing bookmarks can be used to add further intelligence to the data and enhance the application of the geometry features.

## Hole features

### → Hole detection

Within a defined area, the user can search parts for simple holes and stepped holes. *hyperMILL*® also recognises features such as threads and ISO fits if these were saved in a colour table. The search for and grouping of hole features can be controlled using filters, for example according to hole diameter or required workplane. The 5axis drilling option makes it possible to machine holes with different orientations together in a single operation.

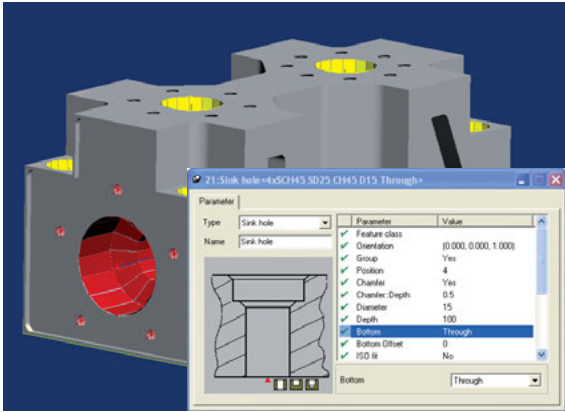

Detection of various holes

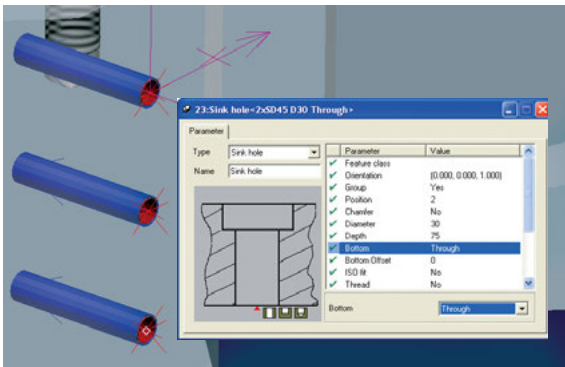

Definition of simple holes as through holes or blind holes

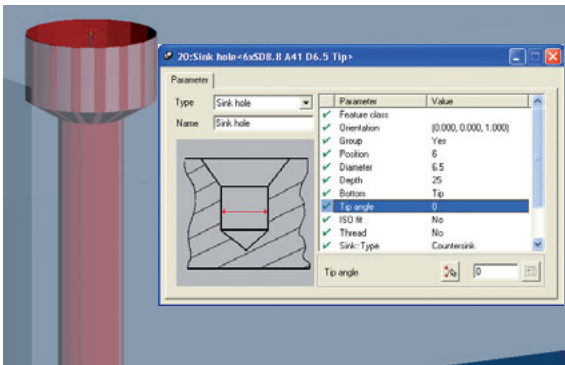

Definition of sink holes as cylinder, cone and stepped

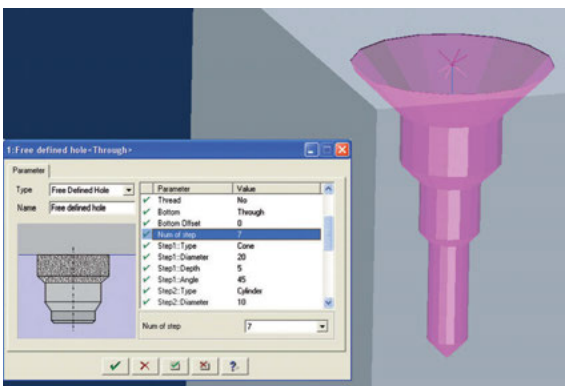

Free definition of holes

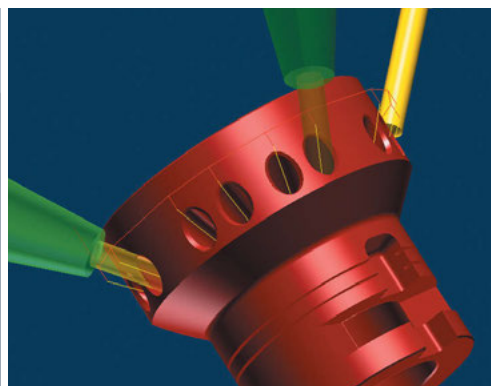

Definition of multi-axis holes

## Pocket feature

### → Automatic pocket recognition

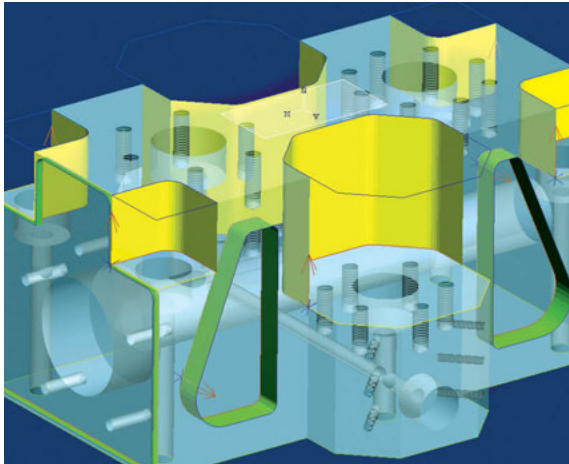

Closed and open pockets

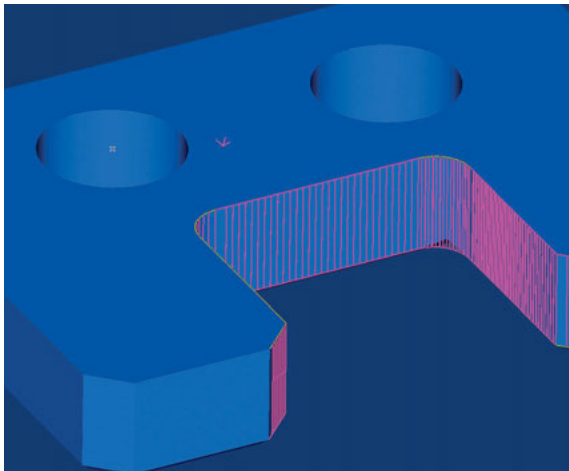

Open pockets without flooring

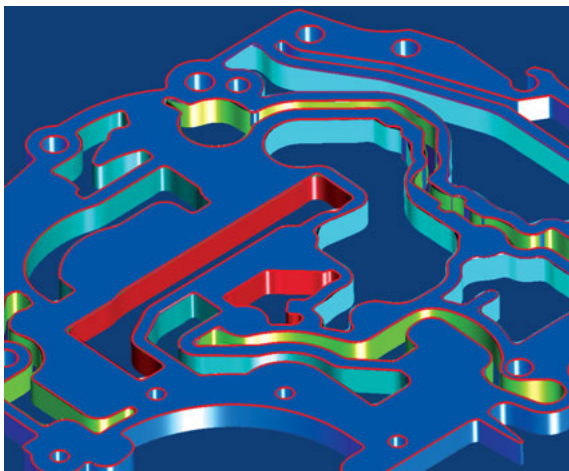

Pockets without a bottom surface

Pocket feature recognition detects closed pockets, pockets with islands, pockets with open sides, completely open pockets (Z-level and breakthrough) and assigns the corresponding machining depth. Sorting and grouping occurs automatically based on workplanes and tool inclinations.

In automatic mode, any closed breakthroughs within the model are detected. In manual mode, users can specify the start and end points to also detect open areas or separate breakthroughs.

## Feature programming

→ Efficient, automated programming

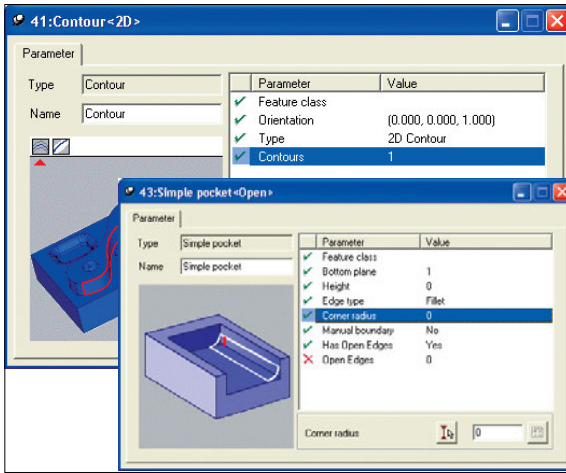

Manual feature definition

Along with the assigned geometries, features contain all information relevant to production, such as top, bottom and start point. These are defined once and can then be assigned to the machining strategy. If the geometry or stored technology parameters are changed while programming, the changes need only be made in the feature. The adjustments made to the feature receive the status “update” for renewed job calculations. They are accounted for automatically during a new calculation.

## Feature browser

→ Feature management

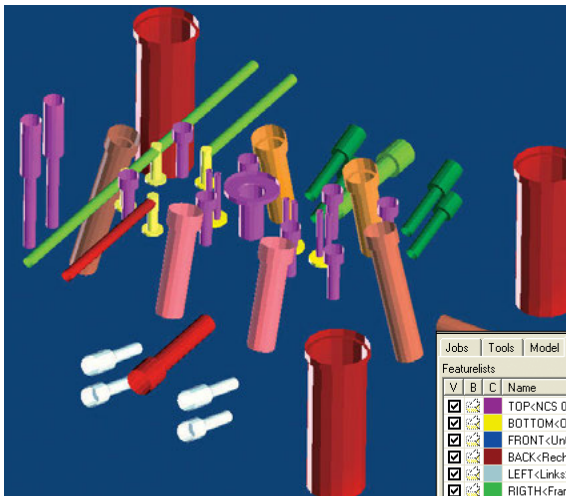

Transparent display of different features or machining sides

The feature browser simplifies the use of features. Users can work with several feature lists at once without losing the overview. For easier identification, features can be displayed in different colours and can be sorted by type, depth, diameter as well as by used and unused features. Features can be found quickly and easily by placing bookmarks.

V	B	C	Name	N
<input checked="" type="checkbox"/>			TOP<NCS_06>	6/6
<input checked="" type="checkbox"/>			BOTTOM<Oberseite>	2/2
<input checked="" type="checkbox"/>			FRONT<Unterseite>	2/2
<input checked="" type="checkbox"/>			BACK<Rechts>	6/6
<input checked="" type="checkbox"/>			LEFT<Links>	1/1
<input checked="" type="checkbox"/>			RIGHT<Frame_9>	2/2
<input checked="" type="checkbox"/>			L36<Frame_19>	1/1
<input checked="" type="checkbox"/>			L37<Frame_22>	1/1
<input checked="" type="checkbox"/>			L38<Frame_23>	1/1
<input checked="" type="checkbox"/>			L39<Frame_10>	2/2
<input checked="" type="checkbox"/>			L40<Frame_12>	1/1
<input checked="" type="checkbox"/>			L41<Frame_13>	1/1
<input checked="" type="checkbox"/>			L42<Frame_14>	1/1
<input checked="" type="checkbox"/>			L43	2/2
<input checked="" type="checkbox"/>			62:Simple hole<6xD5 Through>	
<input checked="" type="checkbox"/>			63:Simple hole<2xD15 Flat>	
<input checked="" type="checkbox"/>			64:Sink hole<8xD15 D9 Through>	
<input checked="" type="checkbox"/>			65:Sink hole<SD40 CH45 D18 Through>	
<input checked="" type="checkbox"/>			66:Sink hole<4xD47 D42 Through>	
<input checked="" type="checkbox"/>			67:Free Defined Hole<4xD34.51A89.82_D14.742A89.7>	
<input checked="" type="checkbox"/>			68:Simple hole<D7.98 Through>	
<input checked="" type="checkbox"/>			69:Simple hole<D20 Flat>	
<input checked="" type="checkbox"/>			70:Simple hole<D7.98 Through>	
<input checked="" type="checkbox"/>			71:Sink hole<SD20 D14 Through>	
<input checked="" type="checkbox"/>			72:Simple hole<10xD10 Flat>	
<input checked="" type="checkbox"/>			73:Simple hole<3xD20.9 Flat>	
<input checked="" type="checkbox"/>			74:Sink hole<5xD10 D5 Through>	

## Macro technology

### → Linking machining strategies and tools with features

With macros, programs can be generated faster and easier than ever. Macros link machining strategies and tools for characteristic geometries. They may consist of one or more jobs. They contain the machining rules for characteristic areas of the corresponding feature, such as thread diameter, sink type and depth, and open or closed pockets. Once machining sequences are stored, they are automatically assigned to the current geometries of the selected feature.

## Macro database

### → Production know-how saved in an easy-to-follow manner

Macros are stored in a database and can be recalled at any time. In addition to macros, the database can also hold images and notes. These are used to document jobs and ensure a well-structured, transparent workflow. This allows macro content to be understood at any time by any user.

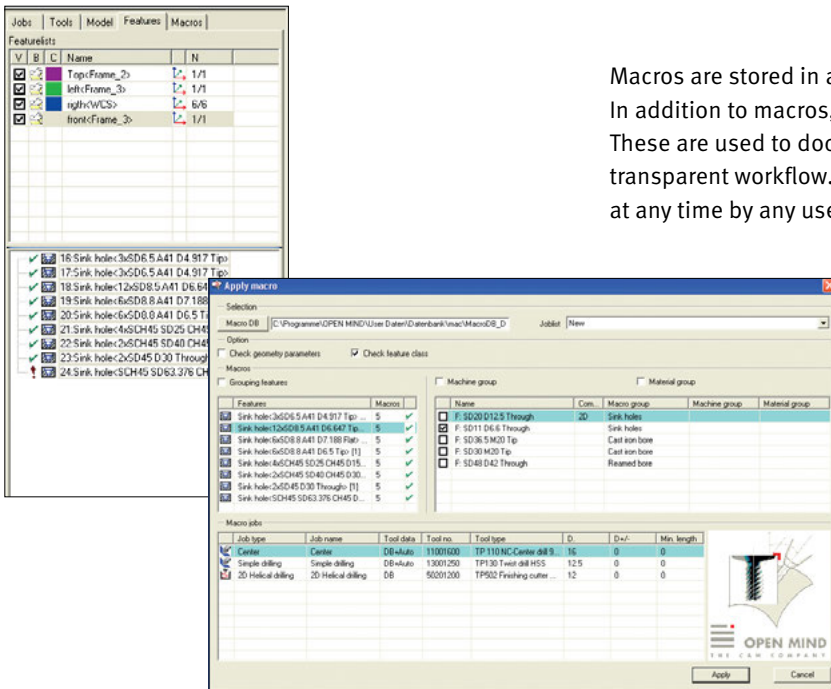

Technology database

## CPF – Customized Process Features (optional)

### → Automation of CAM programming and definition of company-specific machining standards

Extended feature technology allows users to define any type of complex machining sequence and store it as a technology macro so that it can be quickly and easily applied to various similar machining tasks. This is based on process-oriented links between characteristic geometries with freely definable sequences of various machining strategies – from 2D, 3D and 5AXIS milling to turning.

The same elements can be used in various work steps for different tasks. For instance, a surface selection can be used as a stop surface in one step and a milling surface in the next step.

The various geometry elements can be selected manually in the model or selected automatically by defining selection rules. Thus similarly structured external data can be used to quickly program similar components or for making design changes later on.

To facilitate a transparent and easy-to-understand workflow, selections can be named individually, and help texts and explanatory screenshots can be saved.

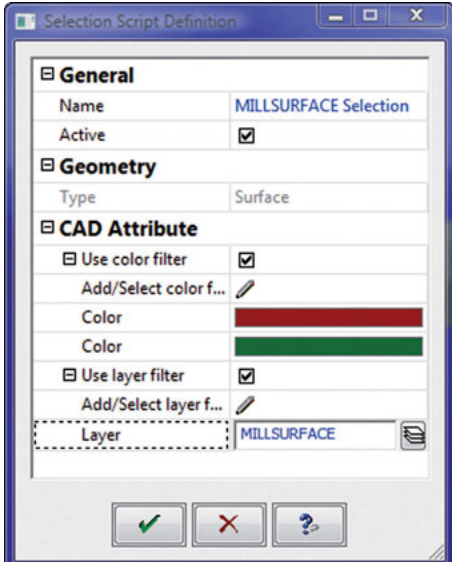

Selection script

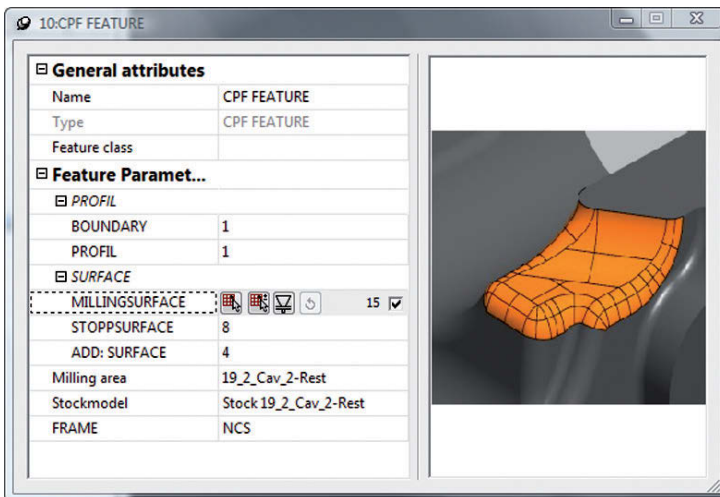

Operating screen for Customized Process Features

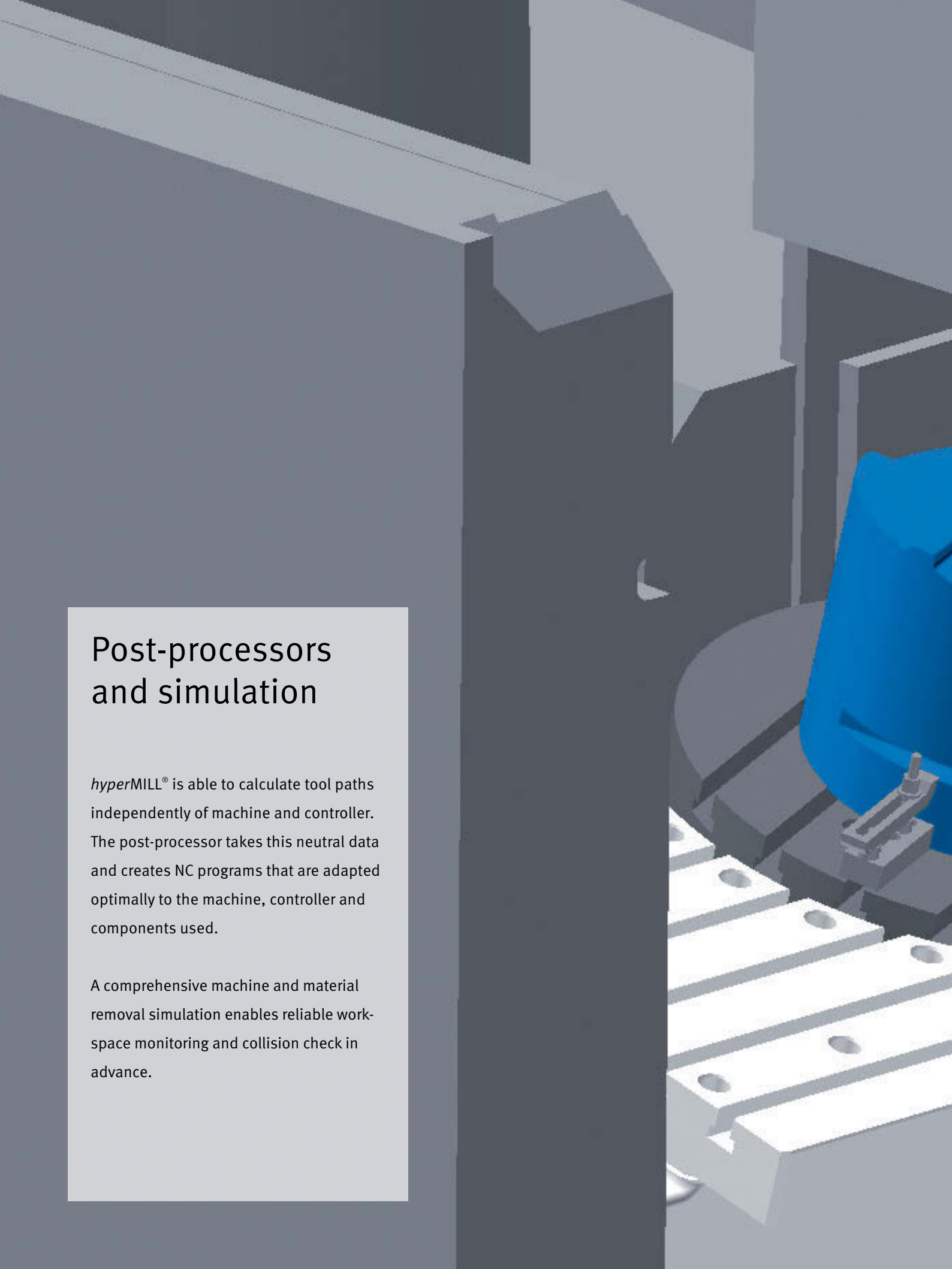
A 3D rendered image of a CNC machine. The tool head is shown in a blue color, positioned above a white worktable. The worktable has several T-slots with circular holes. The background is a dark grey, suggesting the interior of the machine or a simulation environment.

## Post-processors and simulation

*hyperMILL*® is able to calculate tool paths independently of machine and controller. The post-processor takes this neutral data and creates NC programs that are adapted optimally to the machine, controller and components used.

A comprehensive machine and material removal simulation enables reliable work-space monitoring and collision check in advance.



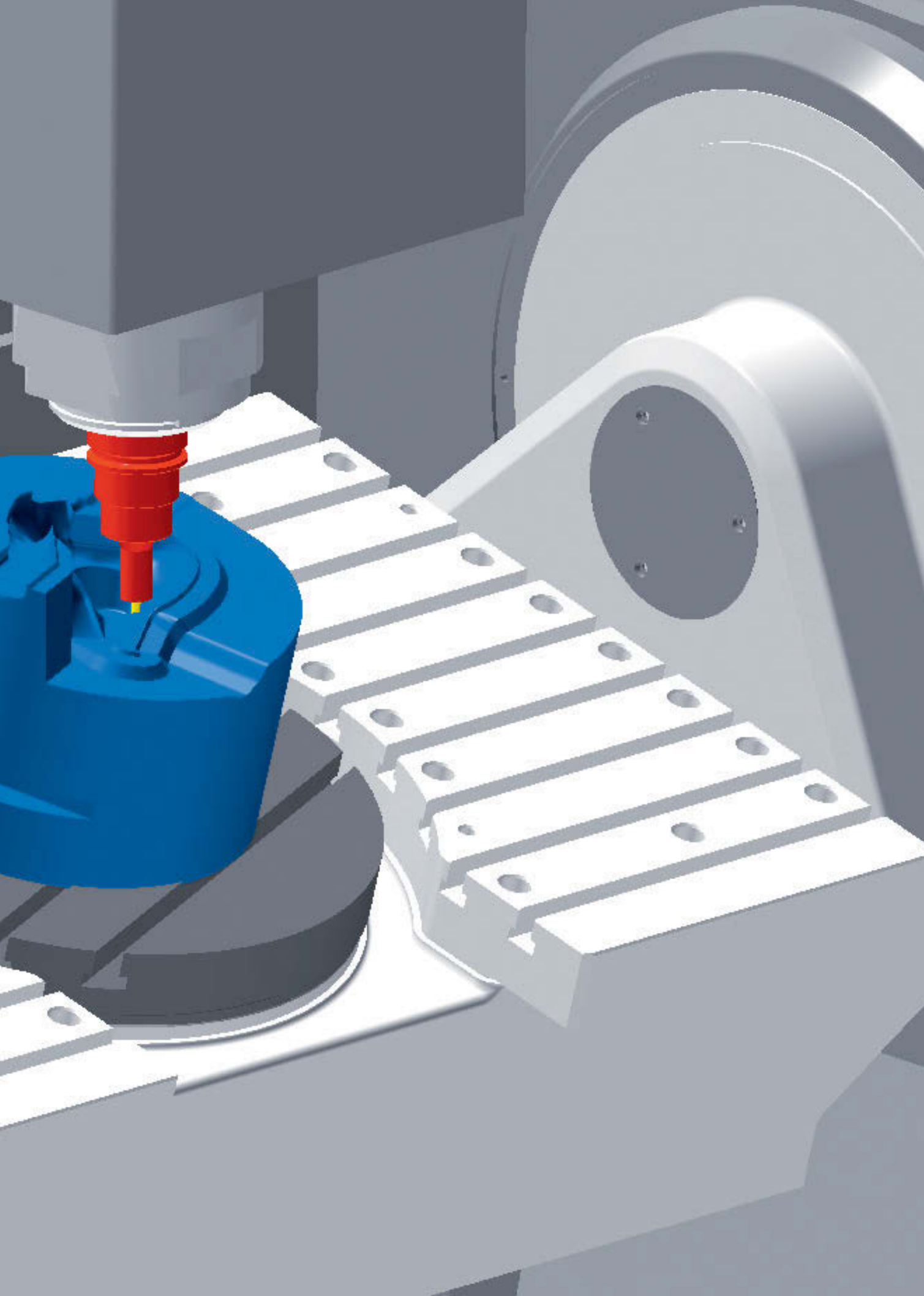

## Post-processor technology

### → Transformation of machine-neutral toolpaths into NC paths adapted to the machine and controller

Because of complex and subtle differences in controllers and machines, as well as individual workpiece requirements, post-processors that have been developed based on customer needs provide the best solutions. Thanks to its customised development, a single post-processor can be offered for all operations from 2D, 3D and 5axis machining to mill turning.

*hyperMILL*® post-processors integrate the complex functionalities of NC controllers, such as:

- 2D canned cycles
- 2D tool radius compensation
- Parameters, such as those for feedrate values
- Sub-routines
- Program part repetitions
- Workplane shifts and tilts
- 5axis simultaneous machining

Even machines of the same type have differences that need to be taken into consideration, especially for multi-axis and 5axis machining.

- Support of nutated rotary axes
- Serrated rotary axes
- Limited angle range for the rotary axis
- Correction of linear offsets depending on the rotational angle (RTCP/TCPM)
- Shortest rotation paths

### Post-processors adapted to the machines, controllers and workpieces used

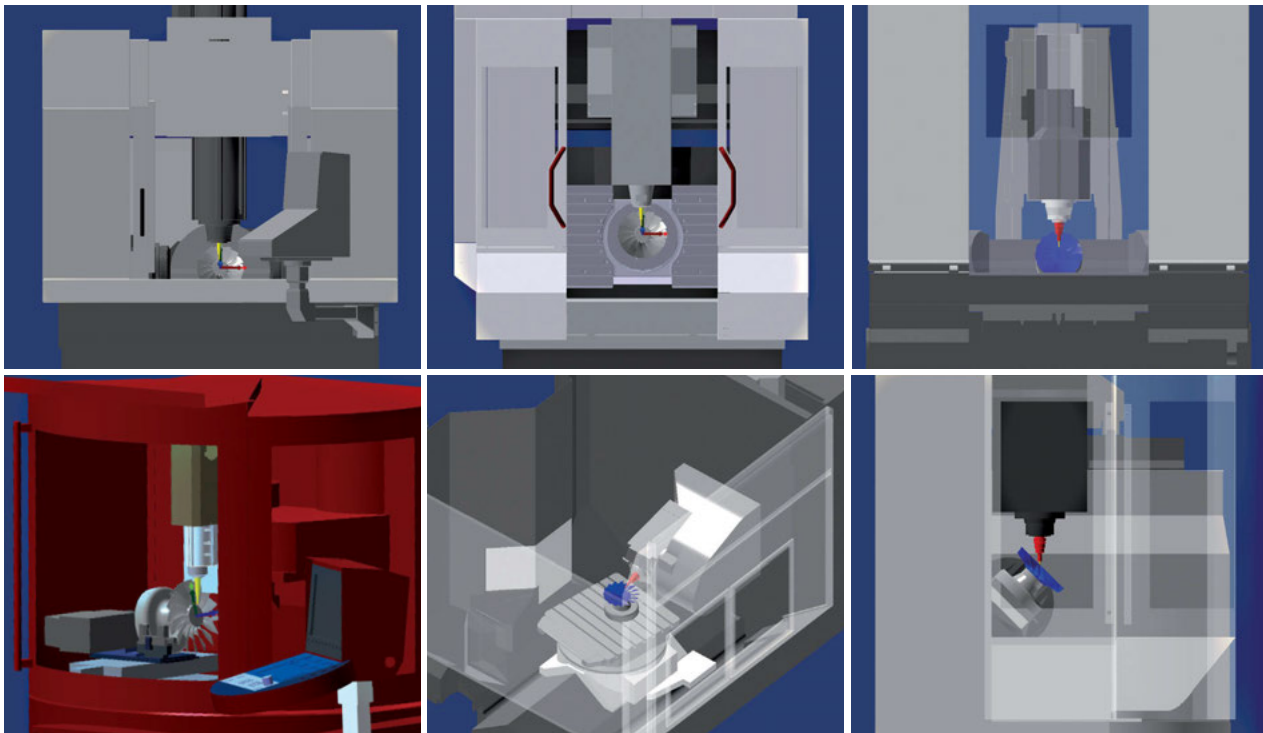

## Simulation

### → Assessment of the created CAM program

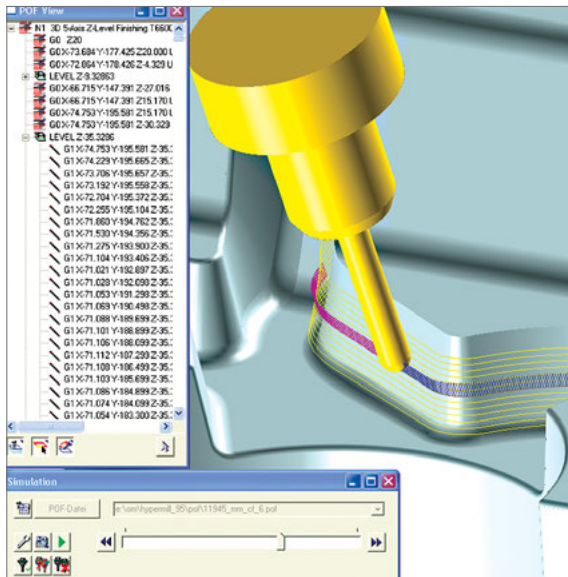

Machining simulation

The graphical simulation of the machining job enables the visual examination of the CAM program created. By turning off milling paths for one or several jobs, overlaps can be prevented. Individual paths are thus better displayed and easier to control.

## Machine and material removal simulation

### → Workspace monitoring and collision testing

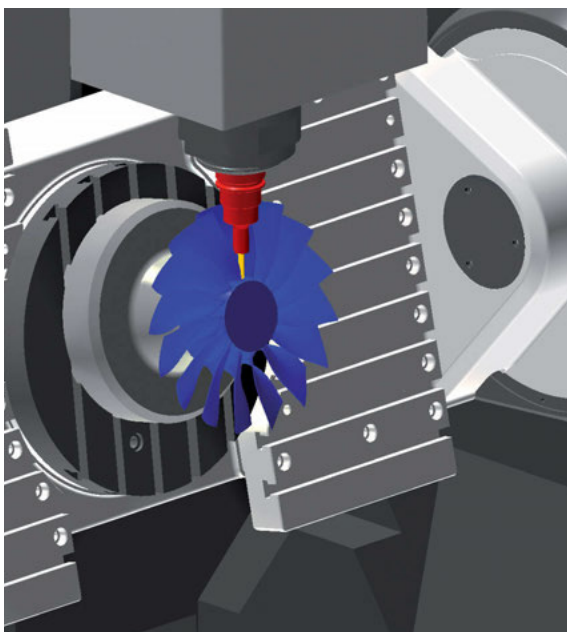

Complete simulation including holder, fixing setup and workpiece

Machine and material removal simulation makes it possible to conduct a detailed monitoring of the workspace. The user can specifically check for potential collisions by looking at the workpiece, holder, fixturing setup and machine movements. In the process, the user can also select whether the simulation should also test for collisions such as:

- Machine against workpiece
- Machine against tool
- Machine against machine
- Machine against holder
- Tool against workpiece
- Setup against machine
- Setup against holder
- Setup against tool
- Holder against model

Collisions are displayed in colour and all NC areas where collisions could occur are saved as a list. If necessary, the CAM program alone can be simulated.

	2D	3D	3+2	Autoindex	5-axis simultaneous	HSC	Stock calculation
Turn roughing/	●						●
Turn finishing	●						●
Groove turning	●						●
Thread cutting	●						●
Centre drilling	●						●
Drilling (with chip breaks)	●		●	●			●
Deep hole drilling	●		●	●			●
Thread drilling and milling	●		●	●			●
Face milling	●		●			●	●
Pocket milling	●		●			●	●
Arbitrary stock roughing		●				●	●
Profile finishing		●	●	●	●	●	●
Z-level finishing		●	●	●	●	●	●
Complete finishing		●	●	●		●	●
Equidistant finishing		●	●	●	●	●	●
ISO machining		●	●	●		●	●
Rework machining		●	●	●	●	●	●
Fillet machining		●	●	●		●	●
Automatic rest machining	●	●	●	●	●	●	●
Free path milling	●	●	●	●	●	●	●
Cutting edge					●	●	●
Top milling					●	●	●
Swarf cutting					●	●	●
Contour machining				●	●	●	●
Tube roughing			●		●	●	●
Tube finishing			●	●	●	●	●
Tube rest machining			●	●	●	●	●
Blade top milling					●	●	●
Blade swarf cutting					●	●	●
Blade transition radius					●	●	●
Multiblade plunge roughing					●	●	●
Multiblade roughing					●	●	●
Multiblade floor finishing					●	●	●
Multiblade blade point contact					●	●	●
Multiblade blade flank contact					●	●	●
Multiblade edge machining					●	●	●
Multiblade fillet milling					●	●	●

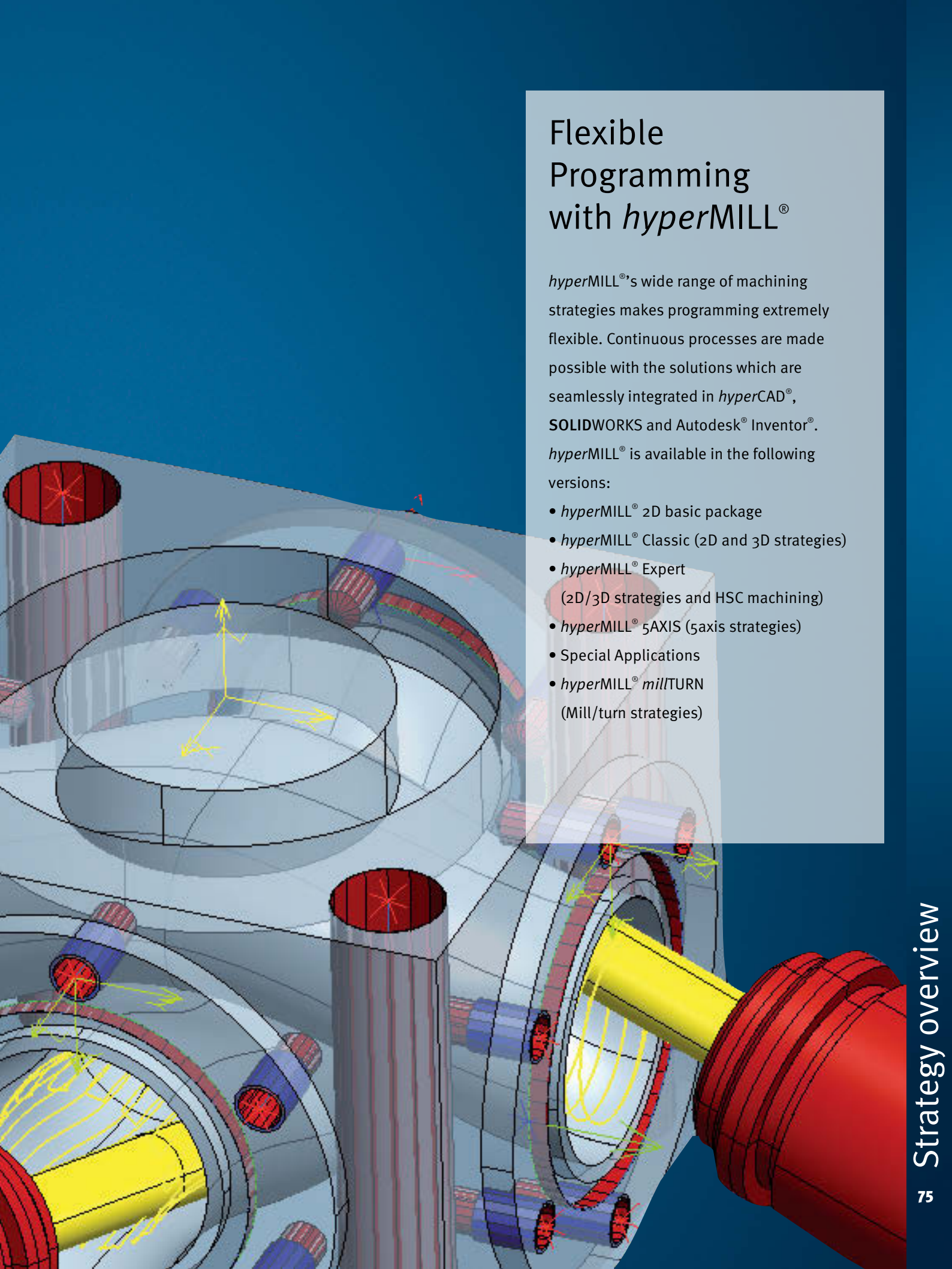

## Flexible Programming with *hyperMILL*®

*hyperMILL*®'s wide range of machining strategies makes programming extremely flexible. Continuous processes are made possible with the solutions which are seamlessly integrated in *hyperCAD*®, **SOLIDWORKS** and Autodesk® *Inventor*®. *hyperMILL*® is available in the following versions:

- *hyperMILL*® 2D basic package
- *hyperMILL*® Classic (2D and 3D strategies)
- *hyperMILL*® Expert (2D/3D strategies and HSC machining)
- *hyperMILL*® 5AXIS (5axis strategies)
- Special Applications
- *hyperMILL*® *millTURN* (Mill/turn strategies)

# Contact

<b>Headquarters</b>	<b>OPEN MIND Technologies AG</b> Argelsrieder Feld 5 • 82234 Wessling • Germany Phone: +49 8153 933-500 E-mail: Info.Europe@openmind-tech.com Support.Europe@openmind-tech.com
<b>UK</b>	<b>OPEN MIND Technologies UK Ltd.</b> Units 1 and 2 • Bicester Business Park Telford Road • Bicester • Oxfordshire OX26 4LN • UK Phone: +44 1869 290003 E-mail: Info.UK@openmind-tech.com
<b>USA</b>	<b>OPEN MIND Technologies USA, Inc.</b> 1492 Highland Avenue, Unit 3 • Needham MA 02492 • USA Phone: +1 888 516-1232 E-mail: Info.Americas@openmind-tech.com
<b>Brazil</b>	<b>OPEN MIND Tecnologia Brasil LTDA</b> Av. Andromeda, 885 SL2021 06473-000 • Alphaville Empresarial Barueri • Sao Paulo • Brasil Phone: +55 11 2424 8580 E-mail: Info.Brazil@openmind-tech.com
<b>Asia Pacific</b>	<b>OPEN MIND Technologies Asia Pacific Pte. Ltd.</b> 33 Ubi Avenue 3 #06-32 • Vertex (Tower B) Singapore 408868 • Singapore Phone: +65 6742 95-56 E-mail: Info.Asia@openmind-tech.com
<b>China</b>	<b>OPEN MIND Technologies China Co. Ltd.</b> Suite 1608 • Zhong Rong International Plaza No. 1088 South Pudong Road Shanghai 200120 • China Phone: +86 21 588765-72 E-mail: Info.China@openmind-tech.com
<b>India</b>	<b>OPEN MIND CAD/CAM Technologies India Pvt. Ltd.</b> #369/4, 1 <sup>st</sup> Floor • 2 <sup>nd</sup> Cross • 1 <sup>st</sup> 'B' Main Road 7 <sup>th</sup> Block, Jayanagar (W) Bangalore – 560070 Karnataka • India Phone: +91 80 2676 6999 E-mail: Info.India@openmind-tech.com
<b>Japan</b>	<b>OPEN MIND Technologies Japan K.K.</b> Misumi Bldg. 3F • 1-17-18, Kichijojihigashicho Musashino-shi • Tokyo 180-0002 • Japan Phone: +81 422 23-5305 E-mail: info.jp@openmind-tech.co.jp
<b>Taiwan</b>	<b>OPEN MIND Technologies Taiwan Inc.</b> Rm. F, 4F., No.1, Yuandong Rd., Banqiao Dist. New Taipei City 22063 • Taiwan Phone: +886 2 2957-6898 E-mail: Info.Taiwan@openmind-tech.com

OPEN MIND Technologies AG is represented worldwide with own subsidiaries and through competent partners and is a member of the Mensch und Maschine technology group, [www.mum.de](http://www.mum.de)

[www.openmind-tech.com](http://www.openmind-tech.com)

## Imprint

© OPEN MIND Technologies AG.  
All rights reserved.  
Issue: April 2019.  
Reproduction in any form is prohibited except with the express written permission of OPEN MIND Technologies AG.

Publisher:  
OPEN MIND Technologies AG  
Argelsrieder Feld 5  
D-82234 Wessling  
E-Mail: [info@openmind-tech.com](mailto:info@openmind-tech.com)  
[www.openmind-tech.com](http://www.openmind-tech.com)

OPEN MIND Technologies AG –  
a member of the Mensch und  
Maschine technology group





We push machining to the limit